

PROLINE

badkamermeubelen / bathroom furniture

*In 5 stappen jouw eigen design
/ In 5 steps your own design*



PROLINE

badkamermeubelen / bathroom furniture

Colofon

Sanibell ontwerpt, ontwikkelt en fabriceert badkamermeubelen in eigen beheer voor de Europese markt. Het complete assortiment is uit voorraad leverbaar.

Contact Sanibell Nederland

Ferrarilaan 8
3261 NC Oud-Beijerland
info@sanibell.nl
www.sanibell.nl
www.prolinebadkamermeubelen.nl

Contact Sanibell België

Sluis 2A unit 2
9810 Eke
info@sanibell.be
www.sanibell.be
www.prolinebadkamermeubelen.be

Internationaal

export@sanibell.nl

Voor meer informatie over Proline bezoekt u onze website of neemt u contact op met één van onze dealers.

De in deze brochure afgebeelde kleuren en foto's geven een indicatie van de werkelijkheid. Een afwijking is mogelijk. Kleurstalen kunt u bekijken en bestellen bij de Proline-dealers. Alle overige gegevens in deze brochure zijn met de grootst mogelijke zorgvuldigheid bijeengebracht en gecontroleerd. Voor eventuele fouten of onvolledigheden en de gevolgen daarvan wordt geen aansprakelijkheid aanvaard. In het belang van vernieuwingen en verbeteringen behouden wij het recht voor wijzigingen in producten aan te brengen.

© Sanibell 2023

Proline is een geregistreerd merk van Sanibell B.V.

/ Colophon

Sanibell designs, develops and manufactures bathroom furniture in house for the European market. The complete range can be delivered from stock.

Contact Sanibell The Netherlands

Ferrarilaan 8
3261 NC Oud-Beijerland
The Netherlands
info@sanibell.nl
www.sanibell.nl
www.prolinebadkamermeubelen.nl

Contact Sanibell Belgium:

Sluis 2A unit 2
9810 Eke
info@sanibell.be
www.sanibell.be
www.prolinebadkamermeubelen.be

International

export@sanibell.nl

For more information about Proline, visit our website or contact one of our dealers.

The colors and photos shown in this brochure give an indication of reality. A deviation is possible. You can view and order color swatches at Proline dealers. All other information in this brochure has been collected and checked with the greatest possible care. No liability is accepted for any errors or omissions and the consequences thereof. In the interest of innovations and improvements, we reserve the right to make changes to products.

© Sanibell 2023

Proline is a registered trademark of Sanibell B.V.

What's new / <i>What's new</i>	04
Intro / <i>Intro</i>	06
Stappenplan / <i>Complete your set step-by-step</i>	08
Type wastafels / <i>Type of washbasins</i>	10
Type onderkasten / <i>Type of washbasin cabinets</i>	12
Porselein Elegant / <i>Porcelain Elegant</i>	16
Porselein Loft / <i>Porcelain Loft</i>	18
Polystone Elegant / <i>Polystone Elegant</i>	22
Polystone Loft / <i>Polystone Loft</i>	24
Hardsteen Elegant / <i>Blue stone Elegant</i>	28
Top afdekplaten & opbouwkommen / <i>Top coverplates & countertop washbasin</i>	30
<small>porselein & hardsteen / porcelain & blue stone</small>	
Hoge kasten & (staal) accessoires / <i>Tall cabinets & steel accessoires</i>	36
Wandplanken / <i>wall shelves</i>	41
Spiegels & spiegelkasten / <i>Mirrors & mirror cabinets</i>	42
Fonteinen Loft / <i>Hand washbasins Loft</i>	46
<small>porselein & hardsteen / porcelain & blue stone</small>	
Fonteinpack Loft / <i>Hand washbasin pack Loft</i>	47
<small>porselein & hardsteen / porcelain & blue stone</small>	
Fonteinen Top / <i>Hand washbasins Top</i>	48
<small>porselein & hardsteen / porcelain & blue stone</small>	
Fontein Top pack / <i>Hand washbasin pack Top</i>	49
Fonteinspiegels / <i>Hand washbasins mirrors</i>	50
Technische tekeningen / <i>Technical drawings</i>	51
Materiaal & onderhoud / <i>Material & maintenance</i>	54
Kleuruitvoeringen / <i>Colour versions</i>	55

WHAT'S NEW?

Het kastenprogramma van Proline is flink gegroeid met nieuwe uitvoeringen en prachtig gefreesde kleuren.
/ Proline's cabinet program has grown significantly with new versions and beautiful milled colors.

Gefreesd in lak */ Milled in lacquer*

De in mat en glans lak uitgevoerde onderkasten hebben ook verticaal gefreesde fronten en een 45 graden greep en sluiten perfect aan op de moderne industriële look. Gecombineerd met een zwart stalen wandframe wordt de badkamer bij uitstek de 'place to be'.

Deze lakkasten zijn verkrijgbaar in de kleuren mat zwart, mat wit en hoogglans wit.

/ Finished in matte and gloss lacquer, the base cabinets also feature vertically milled fronts and a 45-degree handle and perfectly complement the modern industrial look. Combined with a black steel wall frame, the bathroom becomes the place to be. These lacquer cabinets are available in matte black, matte white and high-gloss white.



Mat wit / *Matt white*
Hoogglans wit / *High-gloss white*

Mat zwart / *Matt black*



Gefreesd in lak zwart */ Milled in black lacquer*

Met dit gefreesde meubel zitten we bovenop de trend. Een kleur die zeer gewild is in het moderne interieur. Dit Proline gefreesde lak zwarte badkamermeubel kon ook niet achterblijven in de hedendaagse badkamer.

/ With this milled furniture we are on top of the trend. A colour that is highly sought after in modern interiors. This Proline milled lacquer black bathroom cabinet could not be left behind in today's bathroom either.



Gefreesd in houtkleuren */ Milled in wood colours*

De twee-laden symmetrische onderkasten met houten keerlijst zijn nu ook verkrijgbaar met strak gefreesde fronten in drie prachtige houtdecor kleuren (folie). De houtdecor kleuren Urban oak, Terra oak en Charcoal oak hebben een herkenbare en stoere eiken uitstraling. De met houtdecor folie omtrokken ladefronten vormen een prachtige eenheid met het houtdecor van de corpus.

/ The two-drawer symmetrical base cabinets with wooden rim are now also available with tightly milled fronts in three beautiful wood decor colors (foil). The wood decor colors Urban oak, Terra oak and Charcoal oak have a recognizable and tough oak look. The drawer fronts covered with wood decor foil form a beautiful unity with the melamine wood decor of the carcass.

Urban oak / *Urban oak*

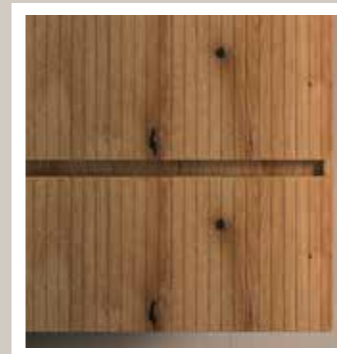

Strakke verticale lijnen met een stoere uitstraling.
/ Tight vertical lines with a tough look.

Terra oak / *Terra oak*

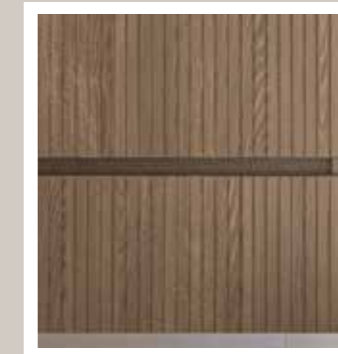

Aardse kleur met mooie belijning.
/ Earthy color with beautiful straight lines.

Charcoal oak / *Charcoal oak*



Moderne en diepe zwarte kleur met regelmatige ribbels.
/ Modern and deep black color with regular ridges.



Black oak */ Black oak*

De nieuwe Proline Black oak decorkleur heeft een prachtige structuur en geeft uw badkamermeubel een modern en stijlvol karakter.

/ The new Proline Black oak decor colour has a beautiful structure and gives your bathroom furniture a modern and stylish character.

Wandplank aan 3-zijde afgekant tbv nis en vrije ophanging */ Wall shelf chamfered on 3 sides for niche and free suspension*

De wandplank is een leuk stijlelement in je nieuwe badkamer en leent zich goed voor bijvoorbeeld een hangplant of maak het persoonlijk met fotolijstjes of andere praktische decoratieve items.

/ The wall shelf is a nice style element in your new bathroom and is ideal for a hanging plant, for example, or make it personal with photo frames or other practical decorative items.

Hoge kasten en fonteinkasten */ High cabinets and fountain cabinets*

In deze Proline meubelnoviteiten worden ook de hoge kasten en de fontein onderkasten niet vergeten. Deze krijgen eveneens de nieuwe kleuren en de gefreesde fronten.

/ In these Proline furniture novelties, the tall cabinets and the small handwashbasin cabinets are not forgotten. These also get the new colors and the milled fronts.





TOP KWALITEIT VOOR EEN BETAALBARE PRIJS
/ TOP QUALITY FOR AN AFFORDABLE PRICE

UIT VOORRAAD LEVERBAAR
/ DELIVERY FROM STOCK

EIGENTIJDS VORMGEGEVEN
/ CONTEMPORARY DESIGNED



De Proline collectie bestaat uit kwalitatieve, mooi vormgegeven en betaalbare badkamermeubelen. De laden van de onderkasten zijn van Hettich; sterke schuiflade systemen van degelijke Duitse A-kwaliteit. De Proline badkamermeubelen kenmerken zich door een comfortabel gebruiksgemak, hoogwaardige en degelijke kwaliteit en een attractieve vormgeving.
/ The Proline collection consists of high-quality, beautifully designed and affordable bathroom furniture. The drawers of the washbasin cabinets are from Hettich; strong drawer systems of solid German A-quality. The Proline bathroom furniture is characterized by a comfortable ease of use, solid and high-quality and an attractive design.



Het complete Proline programma is uit voorraad leverbaar. Vandaag besteld? Morgen in huis!
/ The complete Proline program is available from stock.



Proline badkamermeubelen zijn moderne badkamermeubelen voor een betaalbare prijs en hebben een lange levensduur. Eigentijds vormgegeven en toegepast met de nieuwste kleuren en decors. Met de moderne, industrieel vormgegeven zwarte stalen toevoegingen en accessoires krijgt het badkamermeubel een stoere 'state of the art' look. Zo creëert u altijd een uniek badkamermeubel. Met de ruime keuze uit wastafels van verschillende materialen kunt u alle kanten op. De materialen van de wastafels bestaan uit ambachtelijk porselein, strak en onberispelijk polystone en robuust hardsteen. Keuze genoeg dus. De professionele Proline collectie past uitstekend in de projecten waarbij betaalbaarheid, gebruiksgemak en functionaliteit een eerste vereiste zijn.
/ Proline bathroom furniture are modern bathroom furniture for an affordable price and have a long lifespan. Contemporary designed and applied with the latest colors and decors. The modern, industrially designed black steel additions and accessories give the bathroom furniture a sturdy "state of the art" look. This way you always create a unique bathroom furniture. You can go in all directions with the wide selection of washbasins made of different materials. The materials of the washbasins consist of artisan porcelain, sleek and impeccable polystone and robust blue stone. Enough choice. The professional Proline collection fits perfectly in the projects where affordability, ease of use and functionality are a first requirement.



SERVICE
/ SERVICE



Op het Proline badmeubelprogramma is vanzelfsprekend een gedegen servicebeleid van toepassing. Elke serviceaanvraag wordt serieus opgepakt. Wij vinden altijd een passende oplossing. Wij zijn pas tevreden als u dat ook bent. Indien gewenst kunnen onze eigen servicemonteurs ter plaatse de servicemelding verhelpen. Over de eventuele kosten worden we het wel eens. Ook beschadigde of defecte onderdelen kunnen snel worden uitgeleverd.
/ A sound service policy naturally applies to the Proline bathroom furniture program. Every service request is taken seriously. We always find a suitable solution. We are only satisfied if you are too. If desired, our own service engineers can remedy the service notification on site. We will agree on any costs. Damaged or defective parts can also be delivered quickly.

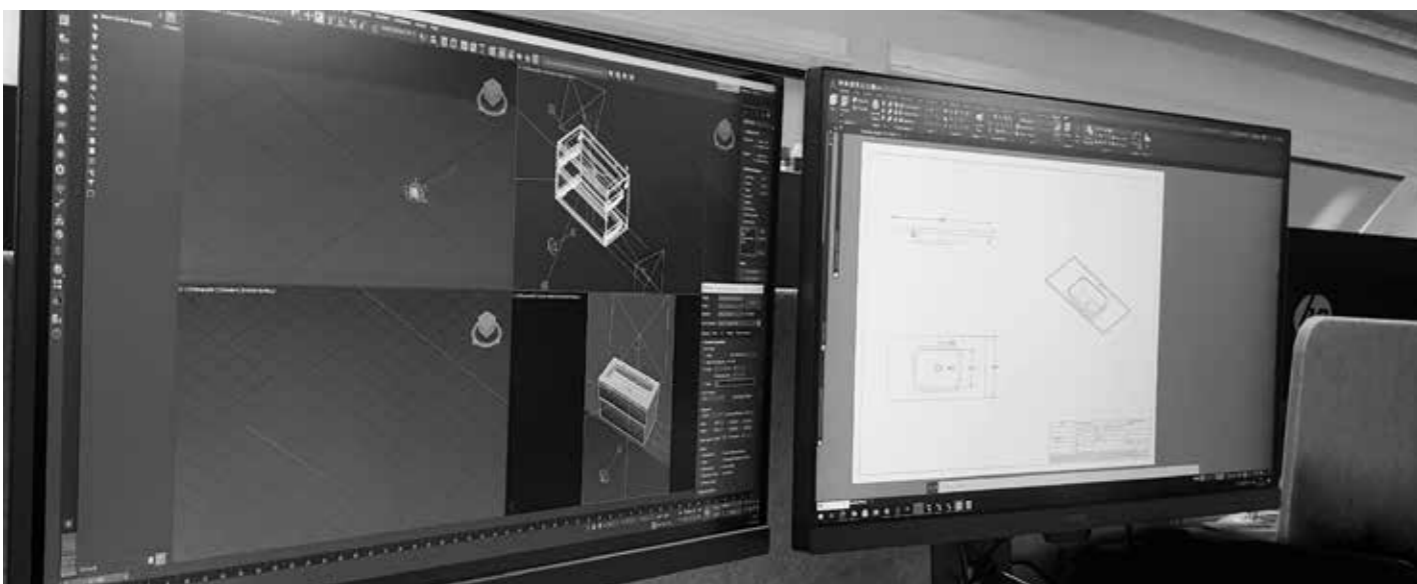

SHOWROOM BEZOEK
/ SHOWROOM VISIT



Wilt u graag een bezoek brengen aan onze uitgebreide showroom? Uiteraard hebben we de complete Proline collectie gepresenteerd onder één dak en stellen we uw bezoek enorm op prijs. Maar maak altijd eerst een afspraak. Bij voorkeur via onze website, waar u een juiste datum en tijdsblok kunt selecteren. Dan maken we ruim de tijd en aandacht voor u vrij. Onze showroom in Oud-Beijerland (vlakbij Rotterdam) is geopend van maandag tot en met vrijdag van 10:00 tot 16:00 uur. De showroom in Eke (België) is uitsluitend te bezoeken op afspraak. Alle verkooptransacties verlopen altijd via de Proline dealer van uw keuze. Sanibell zal hier dan ook altijd terugkoppeling aan geven.
/ Would you like to visit our extensive showroom? We have the complete Proline collection presented under one roof and we greatly appreciate your visit. But always make an appointment first. Preferably through our website, where you can select a correct date and time block. Then we make enough time for your visit. Our showroom in Oud-Beijerland (near Rotterdam) is open from Monday to Friday from 10:00 pm to 16:00 pm. The showroom in Eke (Belgium) can only be visited by appointment. All sales transactions always go through the Proline dealer of your choice. Sanibell will therefore always provide feedback on this.

IN 5 STAPPEN uw eigen design!

1 Kies uw wastafel of opbouwkom

Maak een keuze uit een wastafel of opbouwkom met afdekplaat.
/ Choose your washbasin or countertop washbasin
Choose from a washbasin or countertop washbasin with coverplate.



Porselein Elegant / Porcelain Elegant | Porselein Loft / Porcelain Loft | Polystone Elegant / Polystone Elegant | Polystone Loft / Polystone Loft | Hardsteen Elegant / Blue stone Elegant

Kraangaten wastafels:
/ Tap holes sinks:
0 / 1 / 2 kraangaten
/ 0 / 1 / 2 tap holes

Polystone kleur:
Polystone colour:
Mat of glans wit / Matt or gloss white

Porselein kleur:
/ Porcelain colour:
Glans wit / Gloss white

Hardsteen kleur:
/ Blue stone colour:
Blue stone / Blue stone



Top afdekplaat - verkrijgbaar in alle Proline kleuren
/ Top coverplate - available in all Proline colours:
60 / 80 / 100 / 120 / 140 cm



Top 1. Porselein / Top 1. Porcelain | Top 2. Porselein / Top 2. Porcelain | Top 3. Porselein / Top 3. Porcelain | Top 4. Hardsteen / Top 4. Blue stone | Top 5. Hardsteen zonder kranenbank / Top 5. Blue stone without tap hole | Top 6. Hardsteen met kranenbank / Top 6. Blue stone with tap hole

2 Kies uw breedtemaat onderkast - Ga voor een breedtemaat die geschikt is voor uw badkamer. / Choose your width size washbasin cabinet - Choose a width size that is suitable for your bathroom.

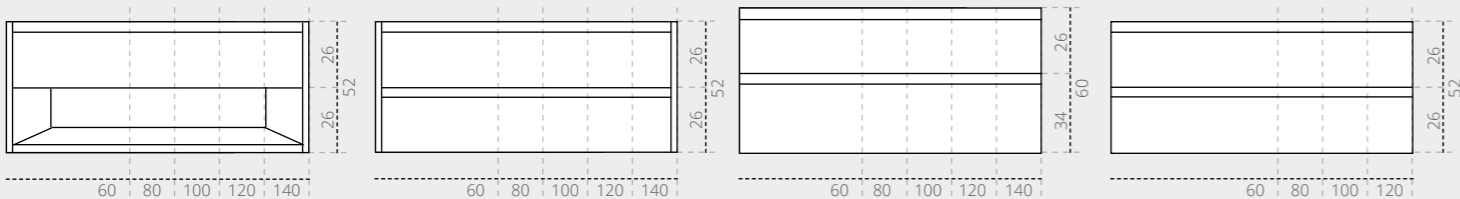

Onderkast 1 lade met open schap en inliggend front
/ Washbasin cabinet 1 drawer with open shelf and straight-in front
60 / 80 / 100 / 120 / 140 x 46 x 52 cm

Onderkast 2 laden symmetrisch met inliggende fronten
/ Washbasin cabinet 2 drawers symmetrical with straight-in front
60 / 80 / 100 / 120 / 140 x 46 x 52 cm

Onderkast 2 laden asymmetrisch met opliggende fronten
/ Washbasin cabinet 2 drawers asymmetrical with straight-up front
60 / 80 / 100 / 120 / 140 x 46 x 60 cm

Onderkast 2 laden symmetrisch met opliggende fronten gefreesd
/ Washbasin cabinet 2 drawers symmetrical with straight-up front milled
60 / 80 / 100 / 120 x 46 x 52 cm

3 Kies uw type onderkast - In uw favoriete kleur. / Choose your type of washbasin cabinet - In your favorite color.



Zijaanzicht / side view
Houtdecor

Onderkast 1 lade met open schap
Houtdecor: de lade heeft een recht invallend front met houten keerlijst.
Verrijgbaar in houtdecor kleuren.
/ Washbasin cabinet 1 drawer with open shelf
Decor: The drawer has a straight-in front with a wooden rim.
Available in wood decor colours.

Zijaanzicht / side view
Houtdecor | Lak

Onderkast 2 laden symmetrisch
Houtdecor: de laden hebben recht invallende fronten met houten keerlijst.
Lak: de laden bovenzijde heeft invallende fronten met een 45 graden afwerking.
Verrijgbaar in houtdecor en lak kleuren.
/ Washbasin cabinet 2 drawers symmetrical
Decor: the drawers have straight-in fronts with wooden rim.
Lacquer: the drawers top has collapsing fronts with a 45-degree finish.
Available in wood decor and lacquer colours.

Zijaanzicht / side view
Houtdecor | Lak

Onderkast 2 laden asymmetrisch
Houtdecor: de laden hebben recht opliggende fronten met houten keerlijst.
Lak: de laden bovenzijde heeft opliggende fronten met een 45 graden afwerking.
Verrijgbaar in houtdecor en lak kleuren.
/ Washbasin cabinet 2 drawers asymmetrical
Decor: both drawers have straight-up fronts with wooden rim.
Lacquer: the drawers top has raised fronts with a 45 degree finish
Available in wood decor and lacquer colours.

Zijaanzicht / side view
Houtdecor gefreesd | Lak gefreesd

Onderkast 2 laden symmetrisch
Houtdecor: de laden hebben recht opliggende fronten met houten keerlijst.
Lak: de laden bovenzijde heeft opliggende fronten met een 45 graden afwerking.
Verrijgbaar in houtdecor gefreesd en lak kleuren.
/ Washbasin cabinet 2 drawers symmetrical
Decor: the drawers have straight-in fronts with wooden rim.
Lacquer: the drawers top has raised fronts with a 45 degree finish
Available in wood decor milled and lacquer colours.

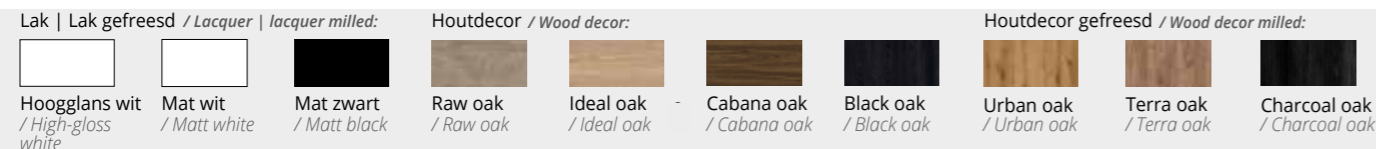

4 Kies uw hoge kast en/of staal accessoires

Creëer nog meer opbergruimte met een hoge kast of staal element.
/ Choose your tall cabinet and/or steel accessories
Create even more storage space with a tall cabinet or steel element.

Hoge kast push to open met inliggend front
/ Tall cabinet push to open with straight-in front

Hoge kast push to open met opliggend gefreesd front
/ Tall cabinet push to open with straight-up milled front

Hoge kast greeploos met 5 open schappen
/ Tall cabinet grippless with 5 open shelves



Lak
Verrijgbaar in 3 kleuren
Houtdecor
Verrijgbaar in 4 kleuren
/ Lacquer Available in 3 colours
Wood decor Available in 4 colours
35 x 35 x 169 cm

Lak gefreesd
Verrijgbaar in 3 kleuren
Houtdecor gefreesd
Verrijgbaar in 3 kleuren
/ Lacquer milled Available in 3 colours
Wood decor milled Available in 3 colours
35 x 35 x 169 cm

Houtdecor
Verrijgbaar in 4 kleuren
/ Wood decor Available in 4 colours
45,5 x 35 x 169 cm

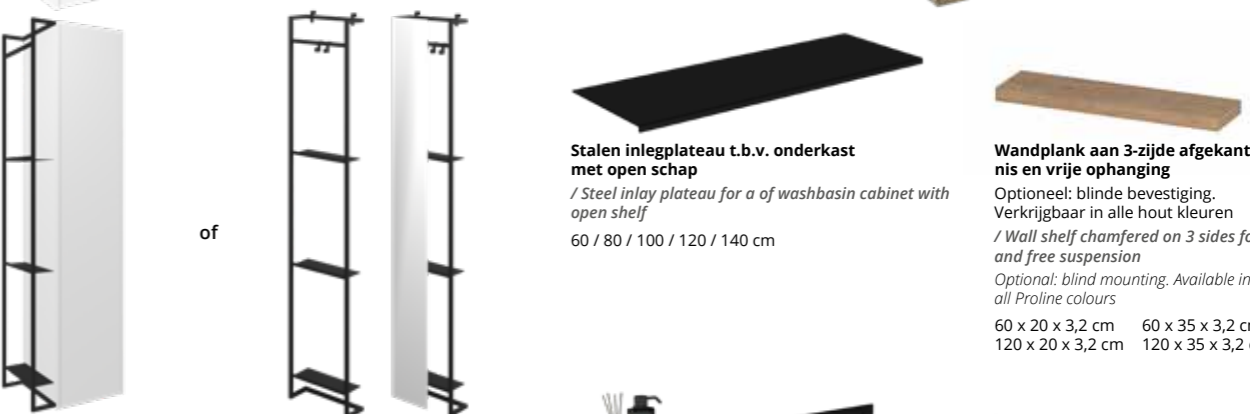

Stalen inlegplateau t.b.v. onderkast met open schap
/ Steel inlay plateau for a of washbasin cabinet with open shelf
60 / 80 / 100 / 120 / 140 cm

Wandplank aan 3-zijde afgekant tbv nis en vrije ophanging
Optioneel: blinde bevestiging. Verrijgbaar in alle hout kleuren
/ Wall shelf chamfered on 3 sides for niche and free suspension
Optional: blind mounting. Available in all Proline colours
60 x 20 x 3,2 cm | 60 x 35 x 3,2 cm | 120 x 20 x 3,2 cm | 120 x 35 x 3,2 cm

Stalen frame
Tegen hoge kast aan te monteren en uit te breiden met passpiegel
/ Steel frame
To mount against tall cabinet and expand with full-length mirror
35 x 11,5 x 169 cm

Stalen frame
Vrij aan de wand te monteren en uit te bereiden met passpiegel (20 x 169 cm)
/ Steel frame
To be mounted freely on the wall and can be extended with a full-length mirror (20 x 169 cm)
35 x 11,5 x 169 cm

Stalen planchet
/ Steel shelf
20 / 40 / 60 / 80 / 100 / 120 / 140 cm

Stalen handdoekbeugel om afdekplaat te ondersteunen
/ Steel towel rail to support coverplate
2 x 44,5 x 12 cm

5 Kies uw spiegel/spiegelkast

Ga voor een spiegel, spiegel met verlichting of een spiegelkast. Zie voor meer info pagina 40/41.
/ Choose your mirror or mirror cabinet
Choose a mirror, a mirror with lighting or a mirror cabinet. For more information, see page 40/41.

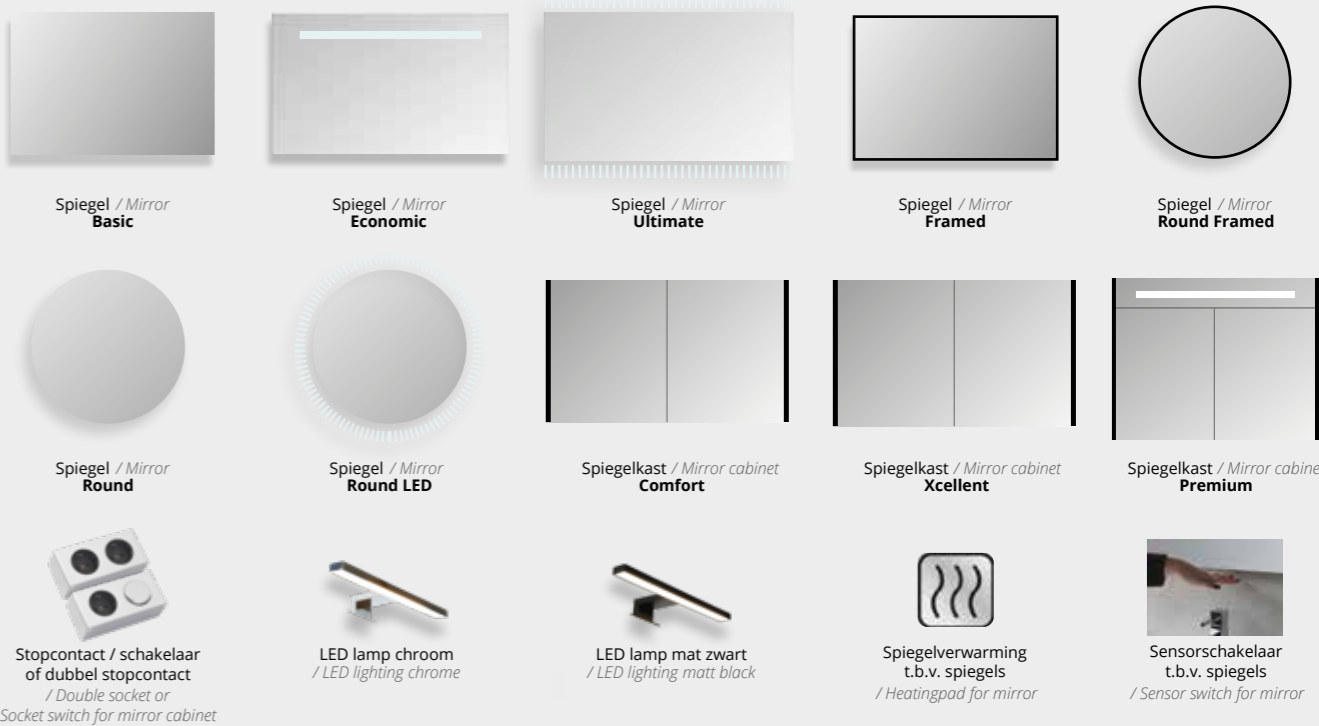

Spiegel / Mirror Basic

Spiegel / Mirror Economic

Spiegel / Mirror Ultimate

Spiegel / Mirror Framed

Spiegel / Mirror Round Framed

Spiegel / Mirror Round

Spiegel / Mirror Round LED

Spiegelkast / Mirror cabinet Comfort

Spiegelkast / Mirror cabinet Xcellent

Spiegelkast / Mirror cabinet Premium

Stopcontact / schakelaar of dubbel stopcontact
/ Double socket or Socket switch for mirror cabinet

LED lamp chroom
/ LED lighting chrome

LED lamp mat zwart
/ LED lighting matt black

Spiegelverwarming t.b.v. spiegels
/ Heatingpad for mirror

Sensorschakelaar t.b.v. spiegels
/ Sensor switch for mirror

TYPE WASTAFELS / TYPE OF WASHBASINS



Porselein Elegant
/ Porcelain Elegant

Met overloop / With overflow

Breedte / Width	Kraangaten / Tap holes		
	0	1	2
60	✓	✓	—
80	✓	✓	—
100	✓	✓	—
120 Enkel / Single	✓	✓	—
120 Dubbel / Double	✓	—	✓
140 Dubbel / Double	✓	—	✓

Verkrijgbaar in glans wit 
/ Available in gloss white



Polystone Loft
/ Polystone Loft

Met overloop / With overflow

Breedte / Width	Kraangaten / Tap holes		
	0	1	2
60	✓	✓	—
80	✓	✓	—
100	✓	✓	✓
120 Enkel / Single	✓	✓	✓
140 Dubbel / Double	✓	—	✓

Verkrijgbaar in glans en mat wit  
/ Available in gloss and matt white

Porselein Loft
/ Porcelain Loft

Met overloop / With overflow

Breedte / Width	Kraangaten / Tap holes		
	0	1	2
60	✓	✓	—
80	✓	✓	—
100	✓	✓	✓
120 Enkel / Single	✓	✓	✓
140 Dubbel / Double	✓	—	✓

Verkrijgbaar in glans wit 
/ Available in gloss white



Hardsteen Elegant
/ Blue stone Elegant

Zonder overloop / Without overflow

Breedte / Width	Kraangaten / Tap holes		
	0	1	2
60	✓	✓	—
80	✓	✓	—
100	✓	✓	—
120 Dubbel / Double	✓	—	✓
140 Dubbel / Double	✓	—	✓

Verkrijgbaar in blue stone 
/ Available in blue stone



Polystone Elegant
/ Polystone Elegant







Zonder overloop / Without overflow

Breedte / Width	Kraangaten / Tap holes		
	0	1	2
60	✓	✓	—
80	✓	✓	—
100	✓	✓	✓
120 Dubbel / Double	✓	—	✓
140 Dubbel / Double	✓	—	✓

Verkrijgbaar in glans en mat wit  
/ Available in gloss and matt white

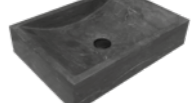

Top opbouwkommen / Top countertop washbasins
Verkrijgbaar in porselein glans / Available in porcelain gloss white
wit en hardsteen / and blue stone

- 
Top 1. Porselein rond Ø40
/ Top 1. Porcelain round Ø40
- 
Top 2. Porselein rond Ø39
/ Top 2. Porcelain round Ø39
- 
Top 3. Porselein rechthoek
/ Top 3. Porcelain rectangle
- 
Top 4. Hardsteen rond Ø40
/ Top 4. Blue stone round Ø40
- 
Top 5. Hardsteen rechthoek
zonder kranenbank
/ Top 5. Blue stone rectangle
without tap hole
- 
Top 6. Hardsteen rechthoek
met kranenbank
/ Top 6. Blue stone rectangle
with tap hole

Top afdekplaten / Top coverplates
Verkrijgbaar in alle Proline kleuren / Available in all Proline colours
60 / 80 / 100 / 120 / 140 cm

Urban oak, Terra oak en Charcoal oak
60 / 80 / 100 / 120 cm

TYPE ONDERKASTEN / TYPE OF WASHBASIN CABINETS

Onderkast open schap

/Lower cabinet open shelf
60 / 80 / 100 / 120 / 140 x 46 x 52 cm

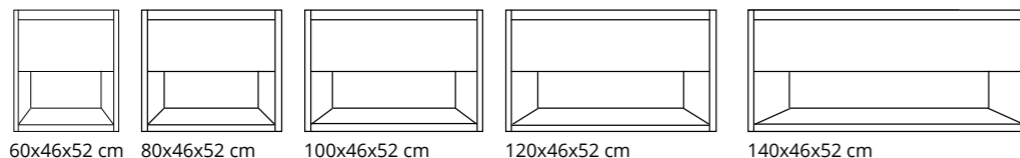

Kleuruitvoeringen:

/Colour versions:



Afwerking front:

De lade heeft een recht invallend front met houten keerlijst en een softclose laden systeem.

/ Front finishing:

The drawer has a straight-in front with a wooden rim and a soft-close drawer system.

Onderkast symmetrisch

/Lower cabinet symmetrical
60 / 80 / 100 / 120 / 140 x 46 x 52 cm

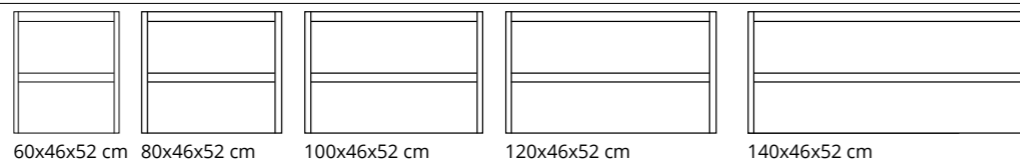

Kleuruitvoeringen:

/Colour versions:

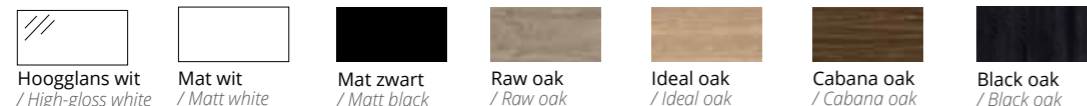

Afwerking fronten:

Houtdecor: de laden hebben recht invallende fronten met houten keerlijst.

Lak: de bovenzijde van de invallende fronten zijn 45 graden afgewerkt.

/ Front finishing:

Wood decor: the drawers have straight up fronts with wooden rim.

Lacquer: the top of the fronts are finished 45 degrees.

Onderkast asymmetrisch

/Lower cabinet asymmetrical
60 / 80 / 100 / 120 / 140 x 46 x 60 cm

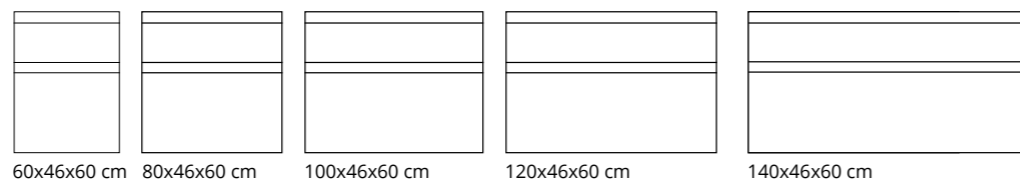

Kleuruitvoeringen:

/Colour versions:

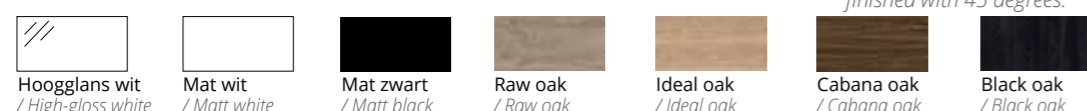

Afwerking fronten:

Houtdecor: beide laden hebben rechte opdek fronten met houten keerlijst.

Lak: de bovenzijde van de fronten zijn 45 graden afgewerkt.

/ Front finishing:

Decor: both drawers have straight up fronts with wooden rim.

Lacquer: the top of the fronts are finished with 45 degrees.

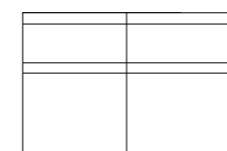

120x46x60 cm - 4 laden*
*alleen i.c.m. wastafel 120 dubbele bak

120x46x60 cm - 4 drawers*
*only in combination with washbasin 120 double basin

Onderkast symmetrisch verticaal gefreesd

/Lower cabinet symmetrical vertical milled
60 / 80 / 100 / 120 x 46 x 52 cm

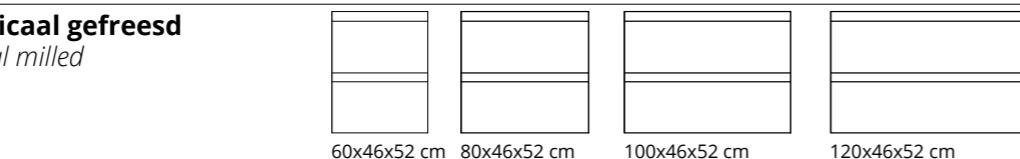

Kleuruitvoeringen:

/Colour versions:

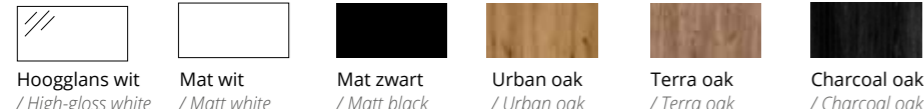

Afwerking fronten:

Houtdecor: de laden hebben recht opvallende fronten met houten keerlijst.

Lak: de bovenzijde van de opvallende fronten zijn 45 graden afgewerkt.

/ Front finishing:

Wood decor: the drawers have straight falling fronts with wooden turning edge.

Lacquer: the top of the falling fronts are finished 45 degrees.

LADE SYSTEEM ONDERKASTEN / DRAWER SYSTEM BASE CABINETS



Onderkast open schap en symmetrisch:

De onderkast met enkele lade met open schap en onderkast dubbele laden symmetrisch zijn uitgevoerd met volledig uittrekbare softclose lade systemen van Hettich. De lade valt hierdoor altijd zachtjes dicht.

/ The lower cabinet with single drawer with open shelf and lower cabinet double drawers symmetrical are equipped with fully extendable soft-close drawer systems by Hettich. As a result, the drawer always closes gently.

Onderkast asymmetrisch:

Ook de onderkast dubbele laden asymmetrisch is uitgevoerd met een volledig uittrekbare softclose lade systeem van Hettich. De onderste lade is uitgevoerd met een hoge reling waardoor flessen, handdoeken en andere badkamerspullen netjes op hun plek blijven.

/ The lower cabinet double drawers asymmetrical is also equipped with a fully extendable soft-close drawer system by Hettich. The bottom drawer is equipped with a high railing that keeps bottles, towels and other bathroom items neatly in place.

PORSELEIN PORCELAIN



Porseleinen wastafels in 2 verschillende hoogtes (Elegant en Loft) en 5 verschillende breedtematen. Te combineren met alle Proline onderkasten.

/ The porcelain washbasins come in 2 different thicknesses (Elegant and Loft) and 5 different widths. They can be combined with all Proline washbasin cabinets.



Wastafel: Porselein Elegant, 60 x 46 x 2 cm, enkele binnenbak, glans wit
/ Washbasin: Porcelain Elegant, 60 x 46 x 2 cm, single innersink, Gloss white



Wastafel: Porselein Elegant, 100 x 46 x 2 cm, enkele binnenbak, glans wit
/ Washbasin: Porcelain Elegant, 100 x 46 x 2 cm, single innersink, gloss white



Wastafel: Porselein Loft, 120 x 46 x 13 cm, enkele binnenbak, glans wit
/ Washbasin: Porcelain Loft, 120 x 46 x 2 cm, single innersink, gloss white



Wastafel: Porselein Loft, 100 x 46 x 13 cm, enkele binnenbak, glans wit
/ Washbasin: Porcelain Loft, 100 x 46 x 2 cm, single innersink, gloss white

Wastafel: Porselein Elegant, 100 x 46 x 2 cm, glans wit | **Onderkast:** Greeploos symmetrisch, 100 x 46 x 52 cm, mat zwart gefreesd | **Spiegel:** Framed mat zwart, 100 x 60 cm
/ Washbasin: Porcelain Elegant, 100 x 46 x 2 cm, gloss white | Washbasin cabinet: Gripless symmetrical, 100 x 46 x 52 cm, matt black milled | Mirror: Framed matt black, 100 x 60 cm



ELE
GANT
ELE
GANT
ELE
GANT

Deze functionele porseleinen wastafel kenmerkt zich door het ruime aflegplateau rondom de binnenbak. De slanke wastafel van maar liefst 2 cm dun is gemakkelijk in onderhoud. Te combineren met alle Proline onderkasten.
/ This functional porcelain washbasin is characterized by the spacious shelf around the inner sink. The slim washbasin of no less than 2 cm thin is easy to clean. Can be combined with all Proline washbasin cabinets.



Wastafel: Porselein Elegant, 120 x 46 x 2 cm, dubbele binnenbak, glans wit
/ Washbasin: Porcelain Elegant, 120 x 46 x 2 cm, double innersink, gloss white



Wastafel: Porselein Elegant, 100 x 46 x 2 cm, glans wit
Onderkast: Greeploos symmetrisch, 100 x 46 x 52 cm, mat zwart gefreesd
/ Washbasin: Porcelain Elegant, 100 x 46 x 2 cm, gloss white | Washbasin cabinet: Gripless symmetrical, 100 x 46 x 52 cm, matt black milled



Wastafel: Porselein Elegant, 120 x 46 x 2 cm, glans wit
Onderkast: Greeploos met open schap, 120 x 46 x 52 cm, Raw oak | **Stalen inlegplateau:** 120 x 2 x 30 cm, mat zwart
/ Washbasin: Porcelain Elegant, 120 x 46 x 2 cm, gloss white | Washbasin cabinet: Gripless with open shelf, 120 x 46 x 52 cm, Raw oak | Steel inlay plateau: 120 x 2 x 30 cm, matt black



Wastafel: Porselein Elegant, 80 x 46 x 2 cm, glans wit | **Onderkast:** Greeploos symmetrisch, 80x46x52, hoogglaans wit | **Spiegel:** Round ø80 cm | **Hoge kast:** hoogglaans wit, 35x35x169 cm
/ Washbasin: Porcelain Elegant, 80 x 46 x 2 cm, gloss white | Washbasin cabinet: Gripless symmetrical, 80x46x52, high-gloss white | Mirror: Round ø80 cm | Tall cabinet: high-gloss white, 35x35x169 cm

Wastafel: Porselein Loft, 80 x 46 x 13 cm, glans wit | **Onderkast:** Greeploos symmetrisch, 80 x 46 x 52 cm, Urban oak gefreesd | **Spiegel:** rond frame ø80 mat zwart
/ Washbasin: Porcelain Loft, 80 x 46 x 13 cm, gloss white | **Washbasin cabinet:** Gripless symmetrical, 80 x 46 x 52 cm, Urban oak milled | **Mirror:** round framed, ø80 cm matt black

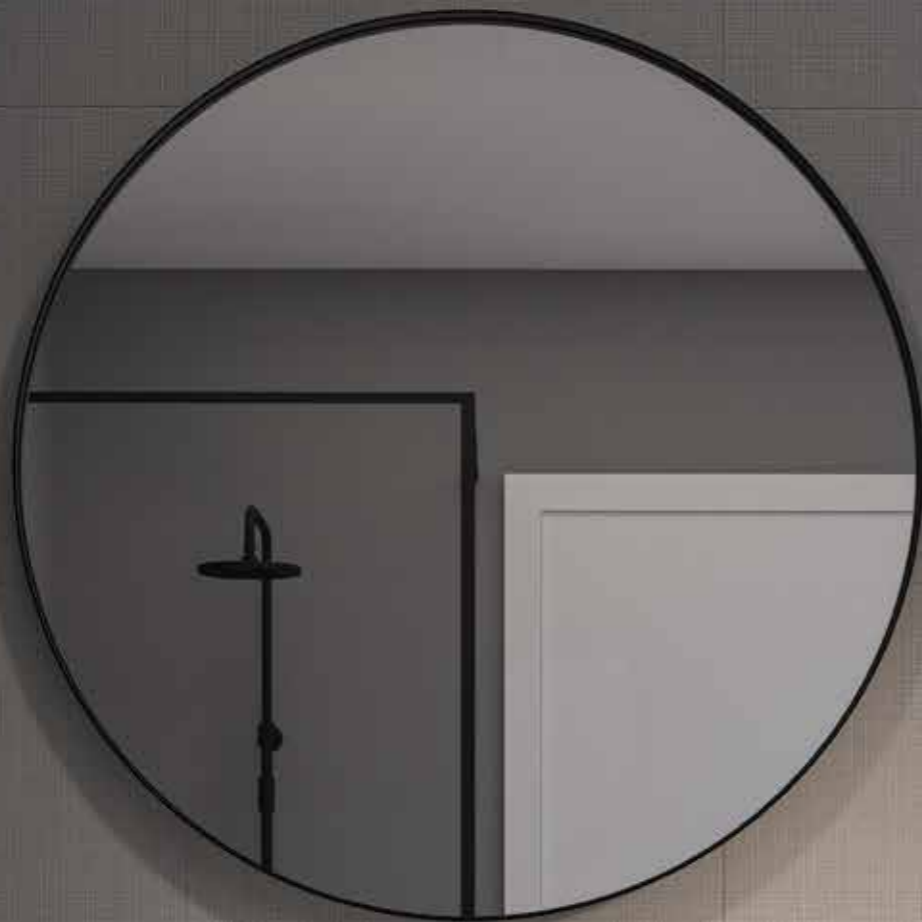

LOFT

De grote diepe binnenbak met dunne strakke randen maken deze wastafel uniek. De porseleinen Loft wastafel is 13 cm hoog en is gemakkelijk in onderhoud. Te combineren met alle Proline onderkasten.
The large deep inner bowl with thin, smooth edges makes this sink unique. The porcelain Loft washbasin is 13 cm high and is easy to clean. Can be combined with all Proline washbasin cabinets.



Wastafel: Porselein Loft, 120 x 46 x 13 cm, glans wit
/ Washbasin: Porcelain Loft, 120 x 46 x 13 cm, gloss white



Onderkast: Greeploos asymmetrisch, 100 x 46 x 60 cm, Cabana oak
/ Washbasin cabinet: Gripless asymmetrical, 100 x 46 x 60 cm, Cabana oak



Wastafel: Porselein Loft, 120 x 46 x 13 cm, glans wit
| Onderkast: Greeploos met schap, Raw oak | **Spiegel:** Ultimate, 120 x 60 cm
/ Washbasin: Porcelain Loft, 120 x 46 x 13 cm, gloss white | **Washbasin cabinet:** Gripless with open shelf, Raw oak | **Mirror:** Ultimate, 120 x 60 cm



Wastafel: Porselein Loft, 80 x 46 x 13 cm, glans wit | **Onderkast:** Greeploos symmetrisch gefreesd, Urban oak | 80 x 46 x 52 cm
/ Washbasin: Porcelain Loft, 80 x 46 x 13 cm, gloss white | **Washbasin cabinet:** Gripless symmetrical milled, 80 x 46 x 52 cm, Urban oak



Wastafel: Porselein Loft, 140 x 46 x 13 cm, glans wit
/ Washbasin: Porcelain Loft, 140 x 46 x 13 cm, gloss white

POLYSTONE POLYSTONE



Polystone wastafels in 2 verschillende diktes, Elegant en Loft, en 5 verschillende breedtematen. Te combineren met alle Proline onderkasten.

/ The polystone washbasins come in 2 different thicknesses (Elegant and Loft) and 5 different widths. They can be combined with all Proline washbasin cabinets.

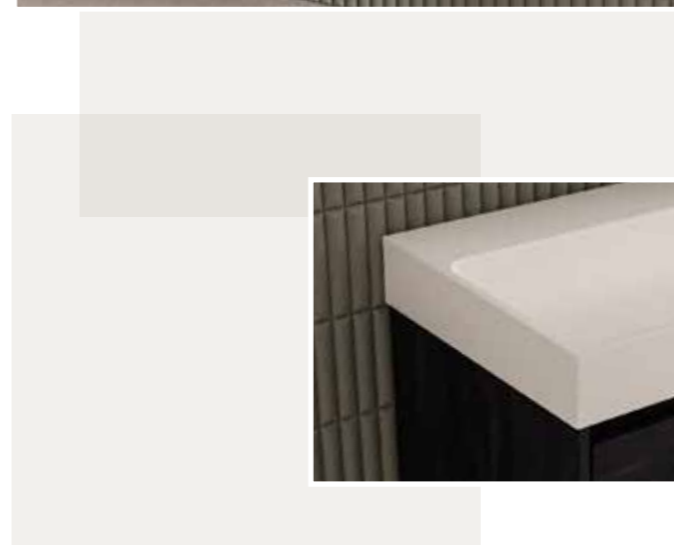
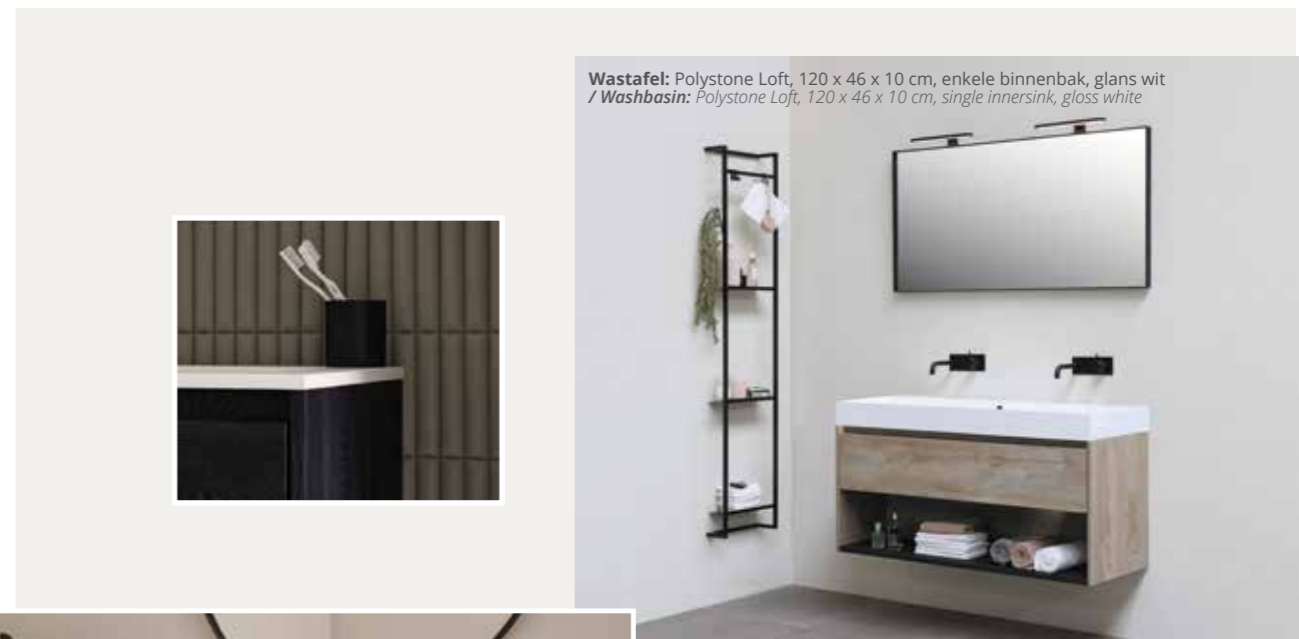

Wastafel: Polystone Elegant, 100 x 46 x 1,5 cm, glans wit | Onderkast: Greploos symmetrisch 100 x 46 x 52 cm, Black oak | Spiegel: Round framed, Ø 80 cm
/ Washbasin: Polystone Elegant, 100 x 46 x 1,5 cm, gloss white | Washbasin cabinet: Gripless symmetrical 100 x 46 x 52 cm, Black oak | Mirror: Round framed, Ø 80 cm



ELEGANT
ELEGANT
ELEGANT

Deze polystone wastafel is 1,5 cm dik. De wastafel heeft een strakke uitstraling, is verkrijgbaar in 5 breedtematen en uitvoerbaar in glans en mat wit. Te combineren met alle Proline onderkasten.
/ This polystone washbasin is only 1.5 cm thin. The washbasin has a sleek look, is available in 5 width sizes and is available in gloss and matt white. Can be combined with all Proline washbasin cabinets.



Wastafel: Polystone Elegant, 100 x 46 x 1,5 cm, glans wit
/ Washbasin: Polystone Elegant, 100 x 46 x 1,5 cm, gloss white



Stalen planchet: 20, 40 en 80 cm, mat zwart
/ Steel shelf: 20, 40 and 80 cm, matt black



Onderkast: Greploos asymmetrisch, 120x46x60 cm, mat wit
/ Washbasin cabinet: Gripless asymmetrical, 120x46x60 cm, matt white



Wastafel: Polystone Elegant, 100x46x1,5 cm, glans wit | Onderkast: Greploos asymmetrisch, 100x46x60 cm, Cabana oak | Spiegel: Round, Ø100 cm
/ Washbasin: Polystone Elegant, 100x46x1,5 cm, gloss white | Washbasin cabinet: Gripless asymmetrical, 100x46x60 cm, Cabana oak | Mirror: Round, Ø100 cm



Wastafel: Polystone Elegant, 140 x 46 x 1,5 cm, glans wit
/ Washbasin: Polystone Elegant, 140 x 46 x 1,5 cm, gloss white



Wastafel: Polystone Elegant, 100 x 46 x 1,5 cm, glans wit
/ Washbasin: Polystone Elegant, 100 x 46 x 1,5 cm, gloss white

Wastafel: Polystone Loft, 100 x 46 x 10 cm, glans wit | Onderkast: Greeploos, 100 x 46 x 52 cm, Black oak | Spiegel: Framed Ø 80 cm
/ Washbasin: Polystone Loft, 100 x 46 x 10 cm, gloss white | Washbasin cabinet: Gripless, 100 x 46 x 52 cm, Black oak | Mirror: Framed Ø 80 cm



LOFT
LOFT

Kenmerkend voor deze polystone wastafel is de afgeronde en glooiende binnenbak. De wastafel is 10 cm dik, verkrijgbaar in 5 breedtematen en leverbaar in glans en mat wit. Te combineren met alle Proline onderkasten.
/ Characteristic for this polystone washbasin is the rounded inner sink. The washbasin is 10 cm thick, available in 5 width sizes and available in gloss and matt white. Can be combined with all Proline washbasin cabinets.



Wastafel: Polystone Loft, 80 x 46 x 10 cm, glans wit | Onderkast: greeploos symmetrisch, 80 x 46 x 60 cm, hoogglans wit
/ Washbasin: Polystone Loft, 80 x 46 x 10 cm, gloss white | Washbasin cabinet: Gripless symmetrical, high-gloss white



Onderkast: Greeploos met open schap, 120 x 46 x 52 cm, Raw oak
/ Washbasin cabinet: Gripless with open shelf, 120 x 46 x 52 cm, Raw oak



Wastafel: Polystone Loft, 100 x 46 x 10 cm, glans wit | Onderkast: greeploos symmetrisch, 100 x 46 x 52 cm, Black oak
/ Washbasin: Polystone Loft, 100 x 46 x 10 cm, gloss white | Washbasin cabinet: Gripless symmetrical, 100 x 46 x 52 cm, Black oak



Wastafel: Polystone Loft, 80x46x10 cm, glans wit | Onderkast: Greeploos symmetrisch, 80x46x52 cm, hoogglans wit | Spiegel: Ultimate 80 cm
/ Washbasin: Polystone Loft, 80x46x10 cm, gloss white | Washbasin cabinet: Gripless symmetrical, 80x46x52 cm, high-gloss white | Mirror: Ultimate 80 cm



HARDSTEEN BLUESTONE

De hardstenen Elegant wastafel met een binnenbak van 7,5 cm diep is verkrijgbaar in 5 verschillende breedtematen. Door het dunne blad is het gewicht van de wastafel beperkt. Te combineren met alle Proline onderkasten.

/ The blue stone Elegant washbasin with an innersink depth of 7,5 cm is available in 5 different widths. The weight of the sink is limited by the thin top. This washbasin can also be combined with all Proline washbasin cabinets.



Wastafel: Hardsteen Elegant, 120 x 46 x 2,5 cm | **Onderkast:** greeploos symmetrisch, 120 x 46 x 52 cm, Ideal oak
/ Washbasin: Hardsteen Elegant, 120 x 46 x 2,5 cm | Washbasin cabinet: Gripless symmetrical, 120 x 46 x 52, Ideal oak



Wastafel: Hardsteen Elegant, 120 x 46 x 2,5 cm | **Onderkast:** greeploos symmetrisch, 120 x 46 x 52 cm, Ideal oak
/ Washbasin: Hardsteen Elegant, 120 x 46 x 2,5 cm | Washbasin cabinet: Gripless symmetrical, 120 x 46 x 52, Ideal oak



Wastafel: Hardsteen Elegant, 120 x 46 x 2,5 cm | **Onderkast:** greeploos symmetrisch, 120 x 46 x 52 cm, Ideal oak
/ Washbasin: Hardsteen Elegant, 120 x 46 x 2,5 cm | Washbasin cabinet: Gripless symmetrical, 120 x 46 x 52, Ideal oak



Wastafel: Hardsteen Elegant, 120 x 46 x 2,5 cm | **Onderkast:** greeploos symmetrisch, 120 x 46 x 52 cm, hoogglans wit gefreesd
/ Washbasin: Hardsteen Elegant, 120 x 46 x 2,5 cm | Washbasin cabinet: Gripless symmetrical, 120 x 46 x 52, high gloss white milled

Wastafel: Hardsteen Elegant 120 x 46 x 2,5 cm | **Onderkast:** Greeploos symmetrisch, 120 x 46 x 52 cm, hoogglans wit gefreesd | **Spiegelkast:** Xcellent, 120 x 14 x 60 cm
/ Washbasin: Blue stone Elegant 120 x 46 x 2,5 cm | **Washbasin cabinet:** Gripless symmetrical, 120 x 46 x 52 cm, high-gloss white milled | **Mirror cabinet:** Xcellent, 120 x 14 x 60 cm



ELEGANT
ELEGANT

Deze hardstenen wastafel is slechts 2,5 cm dik. De wastafel heeft een unieke, stoere uitstraling en is gemakkelijk in onderhoud. Te combineren met alle Proline onderkasten.

/ This blue stone washbasin is only 2,5 cm thick. The washbasin has a unique, sturdy look and is easy to clean. Can be combined with all Proline washbasin cabinets.



Wastafel: Hardsteen Elegant, 80 x 46 x 2,5 cm
/ Washbasin: Blue stone Elegant, 80 x 46 x 2,5 cm



Onderkast: Greeploos symmetrisch, 120 x 46 x 52 Ideal oak
/ Washbasin cabinet: Gripless symmetrical, 120 x 46 x 52 Ideal oak



Onderkast: Greeploos symmetrisch, 120 x 46 x 52 cm hoogglans wit gefreesd
/ Washbasin cabinet: Gripless symmetrical, 120 x 46 x 52 cm high gloss white milled



Wastafel: Hardsteen Elegant, 80x46x2,5 cm | **Onderkast:** Greeploos symmetrisch, 80x46x52 cm, hoogglans wit | **Spiegelkast:** Premium, 80x74x14 cm
/ Washbasin: Blue stone Elegant, 80x46x2,5 cm | **Washbasin cabinet:** Gripless symmetrical, 80x46x52 cm, high-gloss white | **Mirrored cabinet:** Premium, 80x74x14 cm

TOP AFDEKPLATEN TOP COVERPLATES

Met 6 verschillende opbouwkommen is er een ruime keuze in het kommen programma. Porselein of hardsteen, rond of rechthoek, voor ieder wat wils. Te combineren met alle Proline onderkasten en Top afdekplaten.

/ With 6 different countertop washbasins, there is plenty of choice. Porcelain or blue stone, round or rectangle, enough choice for everyone. Can be combined with all Proline base units and Top cover plates.



OPBOUWKOMMEN COUNTERTOP WASHBASINS

Opbouwkom: Top 1. Porselein rond | **Onderkast:** greeploos symmetrisch, Terra oak gefreesd | **Top afdekplaat:** 80 cm, Terra oak | **Spiegel:** Round Led Ø 80 cm
/ Countertop washbasin: Top 1. Porcelain round | Washbasin cabinet: gripless, 80 x 46 x 52 cm, Terra oak milled | Coverplate: 80 cm, Terra oak | Mirror: Round Ø 80 cm



De Proline TOP opbouwkommen zijn er in verschillende kleuren en materialen.
 Porselein glans wit voor een ambachtelijke uitstraling en hardsteen voor een stoere uitstraling.
/ The Proline TOP countertop washbasin come in different colours and materials. Porcelain gloss white for a traditional look and blue stone for a tough look.

TOP opbouwkommen / TOP countertop washbasin



Top 1. Porselein rond Ø40 x 15 cm
/ Top 1. Porcelain round Ø40 x 15 cm



Top 2. Porselein rond Ø39 x 15 cm
/ Top 2. Porcelain round Ø39 x 15 cm



Top 3. Porselein rechthoek 48 x 37 x 13 cm
/ Top 3. Porcelain rectangle 48 x 37 x 13 cm



Top 4. Hardsteen rond Ø40 x 14 cm
/ Top 4. Blue stone round Ø40 x 14 cm











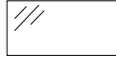

Top 5. Hardsteen rechthoek 50 x 35 x 12 cm
/ Top 5. Blue stone rectangle 50 x 35 x 12 cm



Top 6. Hardsteen rechthoek met kranenbank 50 x 42 x 12 cm
/ Top 6. Blue stone rectangle with tap hole 50 x 42 x 12 cm

Afdekplaten / Coverplates



 Hoogglans wit <i>/ High-gloss white</i>	 Mat wit <i>/ Matt white</i>	 Mat zwart <i>/ Matt black</i>	
 Raw oak <i>/ Raw oak</i>	 Ideal oak <i>/ Ideal oak</i>	 Cabana oak <i>/ Cabana oak</i>	 Black oak <i>/ Black oak</i>
 Blue stone <i>/ Blue stone</i>	 Urban oak <i>/ Urban oak</i>	 Terra oak <i>/ Terra oak</i>	 Charcoal oak <i>/ Charcoal oak</i>



Opbouwkom: Top 2. Porselein rond | **Onderkast:** greeploos asymmetrisch, Cabana oak | **Top afdekplaat:** 100 cm, Cabana oak
/ Countertop washbasin: Top 2. Porcelain round | Washbasin cabinet: gripless asymmetrical, Cabana oak | Coverplate: 100 cm, Cabana oak



Opbouwkom: Top 4. hardsteen rond | **Onderkast:** greeploos symmetrisch 100 cm, hoogglans wit | **Top afdekplaat:** 120 cm, hoogglans wit
/ Countertop washbasin: Top 4. blue stone round | Washbasin cabinet: gripless symmetrical 100 cm, high-gloss white | Coverplate: 120 cm, high-gloss white



Opbouwkomp: Top 2, porselein rond Ø40 x 15 cm | **Onderkast:** Grepeloos asymmetrisch 100 x 46 x 60 cm, Cabana oak | **Top afdekplaat:** 100 x 46 x 3,2 cm, Cabana oak | **Spiegel:** Ultimate 100 x 60 cm | **Hoge kast:** Met 5 vaste open schappen, 45,5 x 35 x 169 cm, Cabana oak
/ **Countertop washbasin:** Top 2, porcelain round ø40 x 15 cm | **Washbasin Cabinet:** Gripless asymmetrical 100 x 46 x 60 cm, Cabana oak | **Coverplate:** 100 x 46 x 3,2 cm, Cabana oak | **Mirror:** Ultimate 100 x 60 cm | **Tall cabinet:** with 5 open shelves, 45,5 x 35 x 169 cm, Cabana oak



Opbouwkomp: Top 3, porselein rechthoek | **Onderkast:** Grepeloos symmetrisch 100 x 46 x 52 cm, mat zwart | **Topplaat:** 120 x 46 x 3,2 cm, mat wit | **Stalen handdoekbeugel:** 2 x 44,5 x 12 cm, mat zwart | **Spiegel:** Rond LED Ø 80 cm
/ **Countertop washbasin:** Top 3, porcelain rectangle | **Washbasin cabinet:** Gripless symmetrical 100 x 46 x 52 cm, matt black | **Coverplate:** 120 x 46 x 3,2 cm, matt white | **Steel towel rail:** 2 x 44,5 x 12 cm, matt white | **Mirror:** Round LED ø100 cm



Opbouwkomp: Top 4, hardsteen rond | **Onderkast:** greeploos met schap, Raw oak | **Top afdekplaat:** 120 x 46 x 3,2 cm, Raw oak
/ **Countertop washbasin:** Top 4, blue stone round | **Washbasin cabinet:** gripless with open shelf, Raw oak | **Coverplate:** 120 cm, Raw oak



Opbouwkomp: Top 4, hardsteen rond | **Onderkast:** Grepeloos symmetrisch 120 cm, Ideal oak | **Topplaat:** 120 x 46 x 2 cm, hardsteen | **Spiegel:** Economic 120 cm
/ **Countertop washbasin:** Top 4, blue stone round | **Washbasin cabinet:** Gripless symmetrical 120 cm, Ideal oak | **Coverplate:** 120 x 46 x 2 cm, blue stone | **Mirror:** Economic 120 cm



Opbouwkomp: Top 5, hardsteen rechthoek | **Onderkast:** Grepeloos asymmetrisch 100 x 46 x 60 cm, mat wit | **Topplaat:** 100 x 46 x 2 cm, hardsteen | **Spiegel:** Basic, 100 x 60 cm | **Spiegel planchet:** 100 cm, mat zwart | **Verlichting:** LED lamp 30 cm, mat zwart
/ **Countertop washbasin:** Top 5, blue stone rectangle | **Washbasin cabinet:** Gripless asymmetrical 100 x 46 x 60 cm, matt white | **Coverplate:** 100 x 46 x 2 cm, blue stone | **Mirror:** Basic, 100 x 60 cm | **Mirror shelf:** 100 cm, matt black | **Lighting:** LED lighting 30 cm, matt black



Opbouwkomp: Top 4, hardsteen rond | **Onderkast:** Grepeloos symmetrisch 120 cm, Ideal oak | **Topplaat:** 120 x 46 x 2 cm, hardsteen
/ **Countertop washbasin:** Top 4, blue stone round | **Washbasin cabinet:** Gripless symmetrical 120 cm, Ideal oak | **Coverplate:** 120 x 46 x 2 cm, blue stone



Opbouwkomp: Top 1, Porselein rond | **Onderkast:** greeploos symmetrisch, Terra oak gefreesd, 80 x 46 x 52 cm | **Top afdekplaat:** 80 cm, Terra oak, 80 x 46 x 3,2 cm
/ **Countertop washbasin:** Top 1, Porcelain round | **Washbasin cabinet:** gripless symmetrical, Terra oak milled, 80 x 46 x 52 cm | **Coverplate:** 80 cm, Terra oak, 80 x 46 x 3,2 cm

HOGGE KASTEN
& staal accessoires



TALL CABINET
& steel accessoires



Creëer extra opbergruimte in de badkamer en kies voor een hoge kast. Proline kent 2 hoge kasten; de strakke 1-deurs kast en de kast met aansluitend 5 open schappen. Met de staalcollectie van Proline maak je het badkamermeubel nog unieker. Een stoer frame aan de kast of meerdere stalen planketten aan de muur; het creëert een trendy effect in de badkamer. Daarnaast ontstaat er ook meer opbergruimte. Een win-win situatie dus!
 / Create extra storage space in the bathroom and choose a tall cabinet. Proline has 2 types; the sleek 1-door tall cabinet and the cabinet with 5 open shelves. With Proline's steel collection, you can make your bathroom furniture even more unique. A sturdy frame on the cabinet or several steel shelves on the wall; it creates a trendy effect in the bathroom. In addition, there is also more storage space!



Frame: Stalen frame t.b.v. hoge kast, 35 x 11,5 x 169 cm, mat zwart
 / **Steel frame:** Against tall cabinet, 35 x 11,5 x 169, matt black



Stalen planket: 20, 40 en 80 cm, mat zwart
 / **Steel shelf:** 20, 40 and 80 cm, matt black



Hoge kast: met 5 vaste open schappen, 45,5 x 35 x 169 cm, Raw oak
 / **Tall cabinet:** with 5 open shelves, 45,5 x 35 x 169 cm, Raw oak

Hoge kast: met 5 vaste open schappen, 45,5 x 35 x 169 cm, Black oak
 / **Tall cabinet:** with 5 open shelves, 45,5 x 35 x 169 cm, Black oak



Stalen inlegplateau: t.b.v. onderkast met open schap, 120 x 2 x 30 cm, mat zwart
/ Steel inlay plateau: for washbasin cabinet with open shelf, 120 x 2 x 30 cm, matt black



Stalen spiegel planchet: 100 cm, mat zwart
/ Steel mirror shelf; 100 cm, matt black



2x Hoge kast: Met 5 open schappen, 45,5x35x169 cm, Raw oak
/ 2x Tall cabinet: With 5 open shelves, 45,5x35x169 cm, Raw oak



Frame: Stalen frame vrij aan de wand te monteren, mat zwart
/ Steel frame: To mount against the wall, matt black



Frame: Stalen frame vrij aan de wand te monteren, incl. passpiegel, mat zwart
/ Steel frame: To mount against the wall, including full length mirror, matt black



Stalen handdoekbeugel: 2 x 44,5 x 12 cm, mat zwart poedercoat
/ Steel towel rail: 2 x 44,5 x 12 cm, matt black powder-coated



Wandplank aan 3-zijde afgekant tbv nis en vrije ophanging
/ Wall shelf chamfered on 3 sides for niche and free suspension



Hoge kast: push to open, 35 x 35 x 169, Charcoal oak gefreesd
/ Tall cabinet: push to open, 35 x 35 x 169, Charcoal oak milled

Hoge kast push to open verkrijgbaar in 7 kleuren
/ Tall cabinet push to open available in 7 colours 35 x 35 x 169 cm

Hoge kast greepeloos met 5 open schappen, verkrijgbaar in Raw oak, Ideal oak, Cabana oak en Black oak
/ Tall cabinet gripless with 5 open shelves, available in Raw oak, Ideal oak, Black oak and Cabana oak 45,5 x 35 x 169 cm

Stalen frame te monteren tegen hoge kast of vrij aan de wand
/ Steel frame to mount against tall cabinet or wall 35 x 11,5 x 169 cm

Passpiegel t.b.v. stalen frame
/ Full length mirror for steel frame 20 x 169 cm

Stalen inlegplateau t.b.v. onderkast met open schap
/ Steel inlay plateau for washbasin cabinet with open shelf 60/80/100/120/140 x 2 x 31 cm

Stalen planchet
/ Steel shelf 20/40/60/80/100/120/140 x 10 x 10 cm

Stalen handdoekbeugel
/ Steel towel rail 2 x 44,5 x 12 cm

Wandplank aan 3-zijde afgekant tbv nis en vrije ophanging
/ Wall shelf chamfered on 3 sides for niche and free suspension

Optioneel: blinde bevestiging
/ Optional: blind mounting
 60 x 20 x 3,2 cm 60 x 35 x 3,2 cm
 120 x 20 x 3,2 cm 120 x 35 x 3,2 cm

SPIEGELS & SPIEGELKASTEN / MIRRORS & MIRROR CABINETS

Met de spiegels en spiegelkasten van Proline maak je het meubel echt af. Alle spiegels en spiegelkasten zijn uit te breiden met extra opties.

/ With the mirrors and mirror cabinets from Proline you really finish the furniture. All mirrors and mirror cabinets can be expanded with additional options.

Basic

Spiegel op aluminium frame
/ Mirror on aluminum frame



Afmetingen / Dimensions:

60 x 3 x 60 cm
80 x 3 x 60 cm
100 x 3 x 60 cm
120 x 3 x 60 cm
140 x 3 x 60 cm

Uit te breiden met / Complete with:



LED lamp
Mat zwart - 30 cm
/ LED lighting
Matt black - 30 cm
IP44 - 4200 K

LED lamp
Chroom - 30 cm
/ LED lighting
Chrome - 30 cm
IP44 - 4200 K



Spiegelverwarming
/ Mirror heating

Sensorschakelaar
/ Sensor switch

Economic

Spiegel op aluminium frame met LED geïntegreerd
/ Mirror on aluminum frame with integrated LED lighting

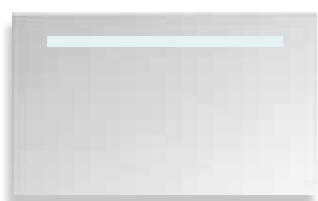

Afmetingen / Dimensions:

60 x 3 x 60 cm
80 x 3 x 60 cm
100 x 3 x 60 cm
120 x 3 x 60 cm
140 x 3 x 60 cm

Uit te breiden met / Complete with:



Spiegelverwarming
/ Mirror heating

Sensorschakelaar
/ Sensor switch

Specificaties / Specifications:

IP44
4200 K

Ultimate

Spiegel op aluminium frame met LED indirect boven- en onderverlichting
/ Mirror on aluminum frame with ambient LED top and bottom lighting



Afmetingen / Dimensions:

60 x 3 x 60 cm
80 x 3 x 60 cm
100 x 3 x 60 cm
120 x 3 x 60 cm
140 x 3 x 60 cm

Uit te breiden met / Complete with:



Spiegelverwarming
/ Mirror heating

Sensorschakelaar
/ Sensor switch

Specificaties / Specifications:

IP44
4200 K

Framed

Spiegel met mat zwart aluminium frame rondom
/ Mirror in matt black powder-coated aluminum frame



Afmetingen / Dimensions:

48 x 4 x 60 cm
60 x 4 x 60 cm
80 x 4 x 60 cm
100 x 4 x 60 cm
120 x 4 x 60 cm
140 x 4 x 60 cm

Uit te breiden met / Complete with:



LED lamp
Mat zwart - 30 cm
/ LED lighting
Matt black - 30 cm
IP44 - 4200 K

LED lamp
Chroom - 30 cm
/ LED lighting
Chrome - 30 cm
IP44 - 4200 K



Spiegelverwarming
/ Mirror heating

Sensorschakelaar
/ Sensor switch

Round Framed

Spiegel rond verzonken in mat zwart kader
/ Round mirror recessed in matt black frame

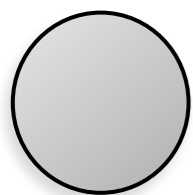

Afmetingen / Dimensions:

Ø60 x 3 cm
Ø80 x 3 cm
Ø100 x 3 cm
Ø120 x 3 cm

Uit te breiden met / Complete with:



Spiegelverwarming
/ Mirror heating
Maximale ruimte voor spiegelverwarming is 30 x 30 cm
/ Maximum space for heating pad is 30 x 30 cm

Round

Spiegel rond op aluminium frame
/ Round mirror on aluminum frame



Afmetingen

/ Dimensions:
Ø60 x 3 cm
Ø80 x 3 cm
Ø100 x 3 cm
Ø120 x 3 cm

Uit te breiden met / Complete with:



LED lamp
Mat zwart - 30 cm
/ LED lighting
Matt black - 30 cm
IP44 - 4200 K

LED lamp
Chroom - 30 cm
/ LED lighting
Chrome - 30 cm
IP44 - 4200 K



Spiegelverwarming
/ Mirror heating
Maximale ruimte voor spiegelverwarming is 30 x 30 cm
/ Maximum space for heating pad is 30 x 30 cm



Sensorschakelaar
/ Sensor switch

Round LED

Spiegel rond op alu frame met indirect LED rondom inclusief sensor schakelaar

/ Round mirror on alu frame with indirect allround LED lighting including sensor switch



Afmetingen / Dimensions:

Ø60 x 3 cm
Ø80 x 3 cm
Ø100 x 3 cm
Ø120 x 3 cm

Specificaties / Specifications:

IP44 - 4200 K

Uit te breiden met: / Complete with:



Spiegelverwarming
/ Mirror heating
Maximale ruimte voor spiegelverwarming is 30 x 30 cm
/ Maximum space for heating pad is 30 x 30 cm

Comfort

Spiegelkast met spiegels aan binnen- en buitenzijde op houten deur

Mirror cabinet with mirrors inside and on front of wooden doors



Afmetingen / Dimensions:

60 x 14 x 60 cm | 1 deur
80 x 14 x 60 cm | 2 deuren
100 x 14 x 60 cm | 2 deuren
120 x 14 x 60 cm | 2 deuren
140 x 14 x 60 cm | 3 deuren

Uit te breiden met:

/ Complete with:



LED lamp
Mat zwart - 30 cm
/ LED lighting
Matt black - 30 cm
IP44 - 4200 K

LED lamp
Chroom - 30 cm
/ LED lighting
Chrome - 30 cm
IP44 - 4200 K

Incl. zijpanelen / Including side panels:

Verkrijgbaar in alle 7 kleuren
/ Available in all 7 colours



Dubbel stopcontact of stopcontact / schakelaar
/ Double socket or socket switch

Xcellent

Spiegelkast met dubbel gespiegelde deuren

Mirror cabinet double mirrored doors



Afmetingen / Dimensions:

60 x 14 x 60 cm | 1 deur
80 x 14 x 60 cm | 2 deuren
100 x 14 x 60 cm | 2 deuren
120 x 14 x 60 cm | 2 deuren
140 x 14 x 60 cm | 2 deuren

Uit te breiden met:

/ Complete with:



LED lamp
Mat zwart - 30 cm
/ LED lighting
Matt black - 30 cm
IP44 - 4200 K

LED lamp
Chroom - 30 cm
/ LED lighting
Chrome - 30 cm
IP44 - 4200 K

Incl. zijpanelen / Including side panels:

Verkrijgbaar in alle 7 kleuren
/ Available in all 7 colours



Dubbel stopcontact of stopcontact / schakelaar
/ Double socket or socket switch

Premium

Spiegelkast met geïntegreerde LED verlichting en spiegels aan buitenzijde op houten deur

Mirror cabinet with integrated LED lighting and mirrors on front of wooden doors



Afmetingen / Dimensions:

60 x 14 x 74 cm | 1 deur
80 x 14 x 74 cm | 2 deuren
100 x 14 x 74 cm | 2 deuren
120 x 14 x 74 cm | 2 deuren
140 x 14 x 74 cm | 3 deuren



Dubbel stopcontact of stopcontact / schakelaar
/ Double socket or socket switch

FONTEINEN HANDWASHBASINS



De Proline fonteinen Loft zijn er in porselein en hardsteen. De fonteinen kunnen vrij aan de wand worden gehangen of worden gecombineerd met het fonteinonderkastje of stalen frame.

Ook de Proline fonteinen Top zijn verkrijgbaar in porselein en hardsteen. Deze opbouw fonteinen zijn te combineren met een stoere afdekplaat welke te plaatsen is op het fonteinonderkastje of stalen frame.

/ The Proline hand washbasins Loft are available in porcelain and blue stone. The hand washbasins can be hung freely on the wall or combined with the hand washbasin cabinet or steel frame.

The Proline hand washbasins Top are also available in porcelain and blue stone. This countertop hand washbasins can be combined with a sturdy cover plate which can be placed on the hand washbasin cabinet or steel frame.



1

Kies uw fontein

/ Choose your hand washbasin



Fontein porselein Loft
/ Hand washbasin porcelain Loft



Fontein hardsteen Loft
/ Hand washbasin blue stone Loft



Fontein porselein Top
/ Hand washbasin porcelain Top



Fontein hardsteen Top
/ Hand washbasin blue stone Top

2

Kies uw stalen frame, afdekplaat of onderkast

/ Choose your steel frame, cover plate or cabinet



Fontein stalen frame mat zwart of geborsteld RVS
/ Hand washbasin steel frame matt black or brushed INOX



Fonteinonderkast effen of verticaal gefreesd
/ Hand washbasin cabinet plain or milled



Fontein afdekplaat + stalen frame mat zwart of geborsteld RVS
/ Hand washbasin coverplate + steel frame matt black or brushed INOX



Fontein afdekplaat + onderkast effen of verticaal gefreesd
/ Hand washbasin coverplate + cabinet plain or milled

3

Kies uw accessoires

/ Choose your accessories



Chroom
/ Chrome

Mat zwart
/ Matt black

Brushed nickel
/ Brushed nickel

- Fonteinkraan staand laag model
- Always open plug
- Design sifon
- Coldwater tap low model
- Always open waste
- Design siphon



Chroom
/ Chrome

Mat zwart
/ Matt black

Brushed nickel
/ Brushed nickel

- Fonteinkraan staand hoog model of wandkraan inkortbaar
- Always open plug
- Design sifon
- Coldwater tap raised model or wall tap (can be shortened)
- Always open waste
- Design siphon

4

Kies uw spiegel

/ Choose your mirror



Fontein plakspiegel
/ Hand washbasin adhesive mirror



Fonteinspiegel op houten plaat
/ Hand washbasin mirror on wooden frame



Fontein plakspiegel
/ Hand washbasin adhesive mirror



Fontein spiegel op alu frame
/ Hand washbasin mirror on alu frame



Fontein plakspiegel rond
/ Hand washbasin adhesive mirror round



Fontein spiegel rond verzonken in mat zwart kader
/ Hand washbasin mirror round recessed in matt black frame

Fontein Loft / Hand Washbasin Loft

De Proline fonteinen Loft zijn er in porselein en hardsteen. De fonteinen kunnen vrij aan de wand worden gehangen of worden gecombineerd met het fonteinonderkastje of stalen frame.

/ The Proline hand washbasins Loft are available in porcelain and blue stone. The hand washbasins can be hung freely on the wall or combined with the hand washbasin cabinet or steel frame.



Fontein: hardsteen Loft | Frame: stalen frame, mat zwart poedercoat
/ Hand washbasin: blue stone Loft | Frame: steel frame, matt black powder-coated



Fontein: porselein Loft | Onderkast: Urban oak gefreesd
/ Hand washbasin: porcelain Loft | Hand washbasin cabinet: Urban oak milled

Fontein Porselein Loft / Hand washbasin porcelain Loft

Links / rechts verkrijgbaar - 1 kraangat
/ Available in left or right - 1 tap hole
40 x 23 x 10 cm (b x d x h) (w x d x h)

Fontein Hardsteen Loft / Hand washbasin blue stone Loft

Links / rechts verkrijgbaar - 0 / 1 kraangat
/ Available in left or right - 0 / 1 tap hole
40 x 23 x 10 cm (b x d x h) (w x d x h)

Stalen frame / Steel frame

Links of rechts, mat zwart poedercoat of geborsteld RVS
/ Left or right, matt black powder-coated or brushed INOX
40 x 23 x 6 cm (b x d x h) (w x d x h)

Uit te breiden met / To complete with:



fonteinonderkast effen en verticaal gefreesd / Hand washbasin cabinet plain or milled

Eén deur links- of rechtsdraaiend, push to open
/ 1 door right or left, push to open
40 x 23 x 40 cm (b x d x h) (w x d x h)

Kleuruitvoeringen fonteinonderkast: / Available colours hand washbasin cabinet:

Lak en lak gefreesd / Lacquer and milled:



Fontein Loft Pack / Hand Washbasin Loft Pack



Verkrijgbaar als fonteinpack! Compleet met kraan, sifon en plug. Handig alles bij elkaar in één set!
/ Available as a pack! Complete with tap, siphon and waste. All together in one set!

Fontein Top / Hand Washbasin Top

Ook de Proline fontein Top is verkrijgbaar in porselein en hardsteen. Deze opbouw fontein is te combineren met een stoere afdekplaat welke te plaatsen is op het fonteinonderkastje of stalen frame.

/ The Proline hand washbasin Top is also available in porcelain and blue stone. This countertop hand washbasin can be combined with a sturdy cover plate which can be placed on the hand washbasin cabinet or steel frame.



Fontein: porselein Top | Afdekplaat: Ideal oak | Frame: stalen frame, mat zwart poedercoat
/ Hand washbasin: porcelain Top | Hand washbasin coverplate: Ideal oak | Frame: steel frame, matt black powder-coated



Fontein: hardsteen Top | Afdekplaat: Raw oak | Onderkast: Raw oak
/ Hand washbasin: blue stone Top | Hand washbasin coverplate: Raw oak | Hand washbasin cabinet: Raw oak

Fontein Porselein Top / Hand washbasin porcelain Top
ø24 x 12,5 cm (d x h) (d x h)

Fontein Hardsteen Top / Hand washbasin blue stone Top
ø24 x 12,5 cm (d x h) (d x h)

Fontein afdekplaat / Hand washbasin coverplate
Lak en houtdecor / Lacquer and decor

40 x 23 x 3,2 cm (b x d x h) (w x d x h)
Hardsteen / Blue stone

40 x 23 x 2 cm (b x d x h) (w x d x h)

Stalen frame / Steel frame

Links of rechts, mat zwart poedercoat of geborsteld RVS
/ Left or right, matt black powder-coated or brushed INOX

40 x 23 x 6 cm (b x d x h) (w x d x h)

Fonteinonderkast effen en verticaal gefreesd
/ Hand washbasin cabinet plain or milled

Eén deur links- of rechtsdraaiend, push to open

/ 1 door right or left, push to open

40 x 23 x 40 cm (b x d x h) (w x d x h)

Kleuruitvoeringen fontein afdekplaat:
/ Available colours hand washbasin coverplate:

Lak: / Lacquer:

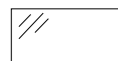

Hoogglans wit
/ High-gloss white



Mat wit
/ Matt white



Mat zwart
/ Matt black

Houtdecor: / Decor:



Raw oak
/ Raw oak



Ideal oak
/ Ideal oak



Cabana oak
/ Cabana oak



Black oak
/ Black oak

Hardsteen:
/ Blue stone:



Blue stone
/ Blue stone

Uit te breiden met: / To complete with:



Always open plug - Chromom
/ Always open waste - Chrome



Design sifon - Chromom
/ Design siphon - Chrome



Always open plug - Mat zwart
/ Always open waste - Matt black



Design sifon - Mat zwart
/ Design siphon - Matt black



Always open plug - Brushed nickel
/ Always open waste - Brushed nickel



Design sifon - Brushed nickel
/ Design siphon - Brushed nickel

Kleuruitvoeringen fontein onderkast:
/ Available colours hand washbasin cabinet:

Lak: / Lacquer:



Hoogglans wit
/ High-gloss white



Mat wit
/ Matt white



Mat zwart
/ Matt black

Houtdecor: / Decor:



Raw oak
/ Raw oak



Ideal oak
/ Ideal oak



Cabana oak
/ Cabana oak



Black oak
/ Black oak

Houtdecor gefreesde onderkast: / Wood decor milled small cabinet:



Urban oak
/ Urban oak



Terra oak
/ Terra oak



Charcoal oak
/ Charcoal oak

Fontein Top Pack / Hand Washbasin Top Pack



Verkrijgbaar als fonteinpack! Compleet met kraan, sifon en plug. Handig alles bij elkaar in één set!
/ Available as a pack! Complete with tap, siphon and plug. All together in one set!

FORTEINSPIEGELS / HAND WASHBASIN MIRRORS

Natuurlijk mag een fonteinspiegel niet ontbreken in het toilet. Met een ruime keuze uit 6 typen spiegels is er voor ieder wat wils!
/ You can't go without a hand washbasin mirror in the toilet. With a large selection of 6 types of mirrors, there is always a mirror that suits you!



Fontein plakspiegel
/ Hand washbasin adhesive mirror
10 x 0,5 x 70 cm



Fontein plakspiegel
/ Hand washbasin adhesive mirror
10 x 0,5 x 100 cm



Fonteinspiegel op houten plaat
/ Hand washbasin mirror on wooden frame
20 x 2 x 70 cm
36 x 2 x 70 cm



Fontein spiegel op alu frame
/ Hand washbasin mirror on alu frame
20 x 3 x 90 cm

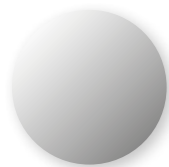

Fontein plakspiegel rond
/ Hand washbasin adhesive mirror round
Ø40 cm



Fontein spiegel rond verzonken in mat zwart kader
/ Hand washbasin mirror round recessed in matt black frame
Ø40 cm
Ø60 cm

TECHNISCHE TEKENINGEN / TECHNICAL DRAWINGS

Afdekplaat lak en houtdecor / Coverplate lacquer and decor

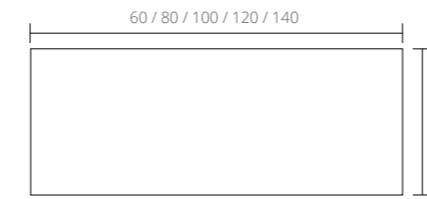

Zijaanzicht / Side view

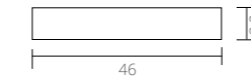

Afdekplaat hardsteen / Coverplate blue stone

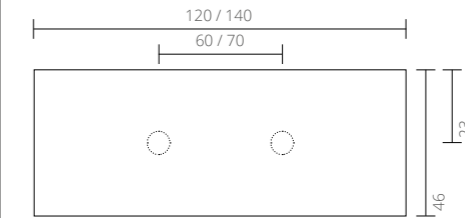
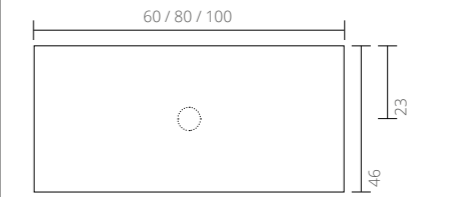

De afdekplaat wordt geleverd met uitsparing t.b.v. opbouwkom
60 / 80 / 100 cm: 1 uitsparing
120 en 140 cm: 2 uitsparingen
/ The cover plate is supplied with a saving for a countertop washbasin
60 / 80 / 100 cm: 1 saving
120 and 140 cm: 2 savings

Zijaanzicht / Side view:

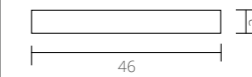

Uit te breiden met / Complete with:



Carekit Hardsteen / Carekit Blue stone

Fontein porselein Loft / Hand washbasin porcelain Loft Glans wit / Gloss white 0 / 1 kraangat / tap holes

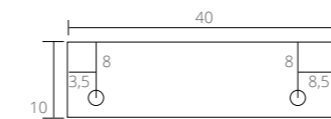
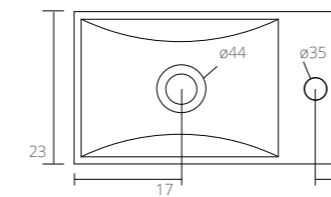

Fontein hardsteen Loft / Hand washbasin blue stone Loft 0 / 1 kraangat / tap holes

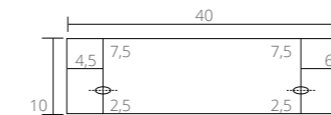
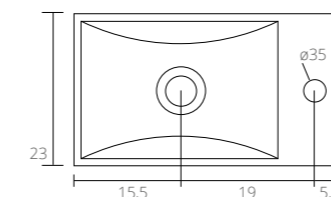

Uit te breiden met / Complete with:

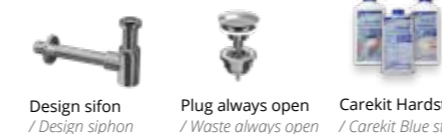

Design sifon / Design siphon
Plug always open / Waste always open
Carekit Hardsteen / Carekit Blue stone

Fontein afdekplaat lak en houtdecor / Hand washbasin coverplate lacquer and decor



Zijaanzicht: / Side view:

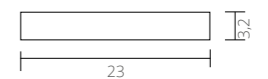

Fontein afdekplaat hardsteen / Hand washbasin coverplate blue stone

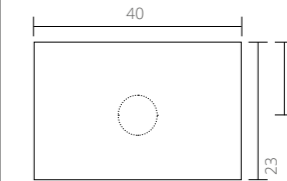

Zijaanzicht: / Side view:

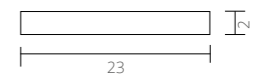

Fontein porselein Loft / Hand washbasin porcelain Loft Glans wit / Gloss white

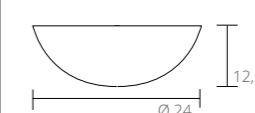
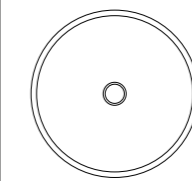

Fontein hardsteen Loft / Hand washbasin blue stone Loft

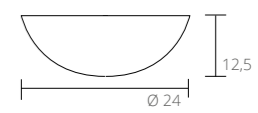
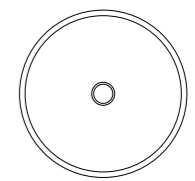

Uit te breiden met: / Complete with:

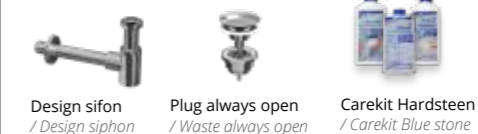

Design sifon / Design siphon
Plug always open / Waste always open
Carekit Hardsteen / Carekit Blue stone

TECHNISCHE TEKENINGEN / TECHNICAL DRAWINGS

Porselein Elegant / Porcelain Elegant
Glans wit / Gloss white
0 / 1 / 2 kraangaten / tap holes

60 cm - 0 / 1 kraangat / tap hole

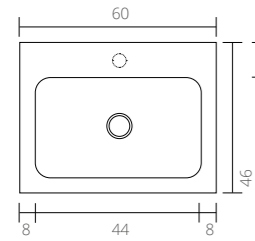

80 cm - 0 / 1 kraangat / tap hole

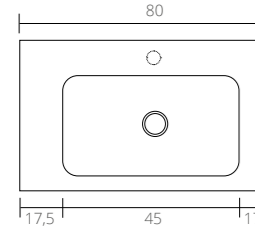

100 cm - 0 / 1 kraangat / tap hole

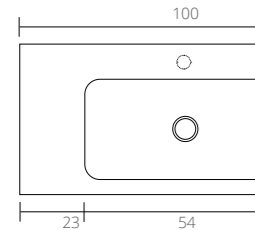

120 cm - 0 / 1 kraangat / tap hole

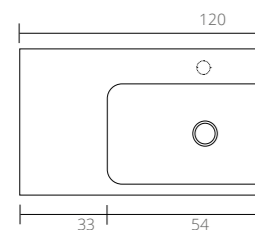

120 cm - 0 / 2 kraangaten / tap holes

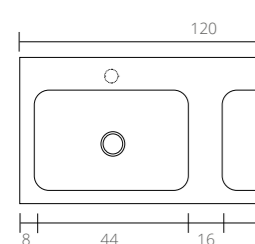

140 cm - 0 / 2 kraangaten / tap holes

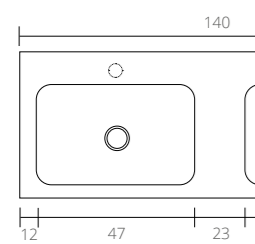

Zijaanzicht - diepte binnenbak
 / Side view - depth inner sink

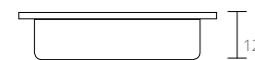

Uit te breiden met: / Complete with:



Meubelsifon PVC
 / Furniture siphon PVC
Plug stop & go of always open
 / Plug stop & go or always open

Porselein Loft / Porcelain Loft
Glans wit / Gloss white
0 / 1 / 2 kraangaten / tap holes

60 cm - 0 / 1 kraangat / tap hole

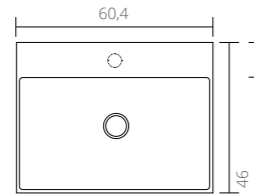

80 cm - 0 / 1 kraangat / tap hole

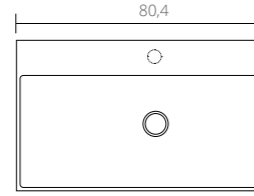

100 cm - 0 / 1 / 2 kraangaten / tap holes

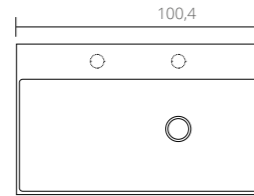

120 cm - 0 / 1 / 2 kraangaten / tap holes

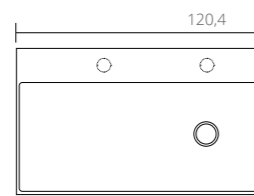

140 cm - 0 / 2 kraangaten / tap holes

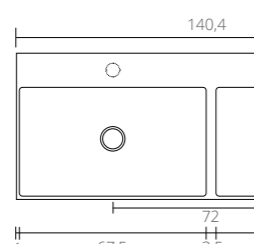

Zijaanzicht - diepte binnenbak
 / Side view - depth inner sink

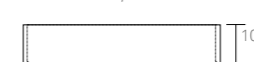

Uit te breiden met: / Complete with:



Meubelsifon PVC
 / Furniture siphon PVC
Plug stop & go of always open
 / Plug stop & go or always open

Polystone Elegant / Polystone Elegant
Glans en mat wit / Gloss & matt white
0 / 1 / 2 kraangaten / tap holes

60 cm - 0 / 1 kraangat / tap hole

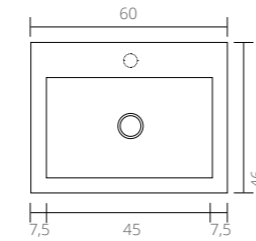

80 cm - 0 / 1 kraangat / tap hole

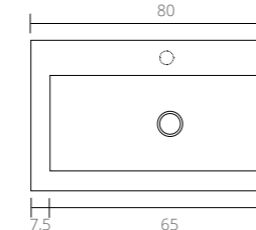

100 cm - 0 / 1 / 2 kraangaten / tap holes

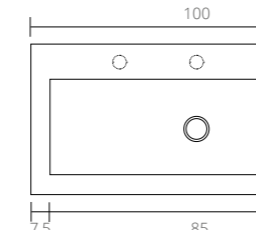

120 cm - 0 / 2 kraangaten / tap holes

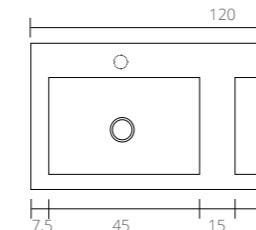

140 cm - 0 / 2 kraangaten / tap holes

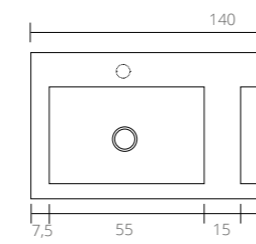

Zijaanzicht - diepte binnenbak
 / Side view - depth inner sink

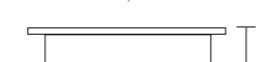

Uit te breiden met: / Complete with:



Meubelsifon PVC
 / Furniture siphon PVC
Plug stop & go of always open
 / Plug stop & go or always open

Polystone Loft Polystone Loft
Glans en mat wit / Gloss & matt white
0 / 1 / 2 kraangaten / tap holes

60 cm - 0 / 1 kraangat / tap hole

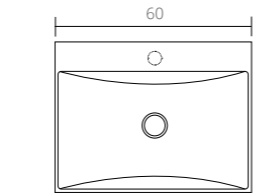

80 cm - 0 / 1 kraangat / tap hole

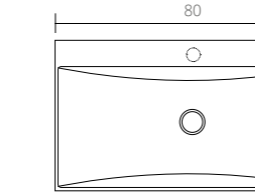

100 cm - 0 / 1 / 2 kraangaten / tap holes

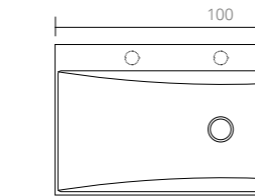

120 cm - 0 / 1 / 2 kraangaten / tap holes

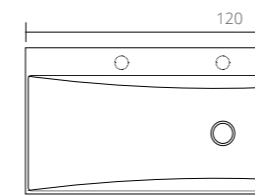

140 cm - 0 / 2 kraangaten / tap holes

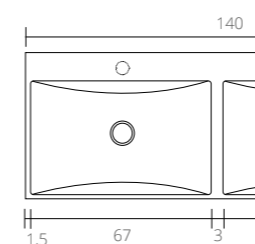

Zijaanzicht - diepte binnenbak
 / Side view - depth inner sink

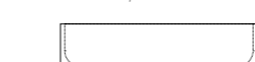

Uit te breiden met: / Complete with:



Meubelsifon PVC
 / Furniture siphon PVC
Plug stop & go of always open
 / Plug stop & go or always open

Hardsteen Elegant / Blue stone Elegant
0 / 1 / 2 kraangaten / tap holes

60 cm - 0 / 1 kraangat / tap hole

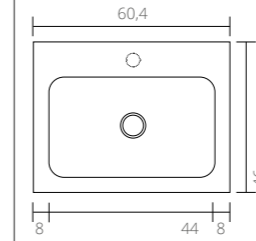

80 cm - 0 / 1 kraangat / tap hole

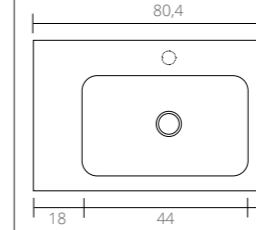

100 cm - 0 / 1 kraangat / tap hole

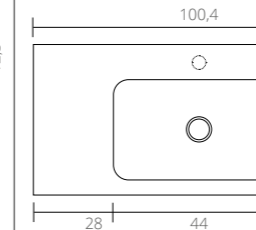

120 cm - 0 / 2 kraangaten / tap holes

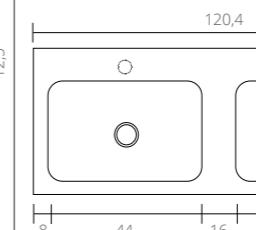

140 cm - 0 / 2 kraangaten / tap holes

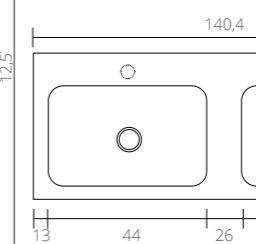

Zijaanzicht - diepte binnenbak
 / Side view - depth inner sink



Uit te breiden met: / Complete with:



Meubelsifon PVC
 / Furniture siphon PVC
Plug stop & go of always open
 / Plug stop & go or always open
Carekit Hardsteen
 / Carekit Blue stone

Top opbouwkommen / Top countertop washbasins
Porselein glans wit & hardsteen
/ Porcelain gloss white & blue stone

Top 1. Porselein rond Ø40
 / Top 1. Porcelain round Ø40

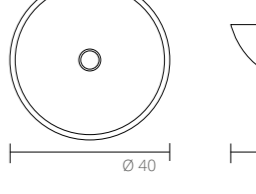

Top 2. Porselein rond Ø39
 / Top 2. Porcelain round Ø39

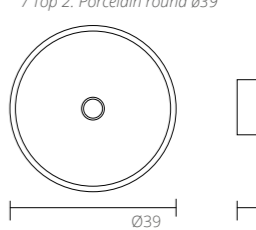

Top 3. Porselein rechthoek
 / Top 3. Porcelain rectangle

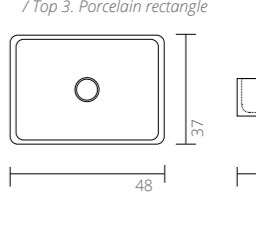

Top 4. Hardstenen kom rond Ø40
 / Top 4. Blue stone round Ø40

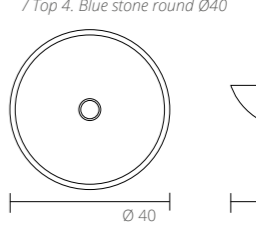

Top 5. Hardstenen kom rechthoek z/kranenbank
 / Top 5. Blue stone rectangle without tap hole

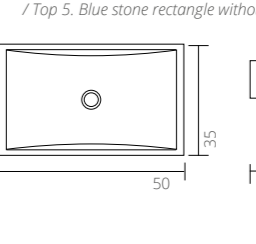

Top 6. Hardstenen kom rechthoek m/kranenbank
 / Top 6. Blue stone rectangle with tap hole

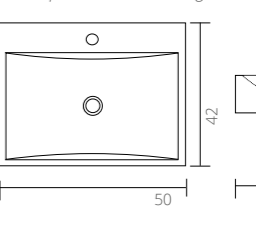

Uit te breiden met: / Complete with:



Meubelsifon PVC
 / Furniture siphon PVC
Plug stop & go of always open
 / Plug stop & go or always open
Carekit Hardsteen
 / Carekit Blue stone

MATERIAAL & ONDERHOUD / MATERIAL & MAINTENANCE

PORSELEIN / PORCELAIN

Het oppervlak van alle keramische/porseleinen wastafels bestaat uit een geglaazuurde, dunne, glasachtige laag. Keramiek kenmerkt zich door de gebruiksvriendelijkheid en het gladde oppervlak. Dat wil niet zeggen dat het ongevoelig is voor beschadigingen. Harde, vallende objecten kunnen het glazuur beschadigen en dat kan leiden tot onherstelbare scheuren en oppervlaktebeschadigingen.

Verwijderen van vlekken

Voor de dagelijkse reiniging kunt u normale schoonmaakmiddelen, zoals allesreinigers, voor sanitair gebruiken. Eventuele kalkresten kunnen bijvoorbeeld verwijderd worden met de in de handel verkrijgbare kalkverwijderaars of de reguliere op azijn gebaseerde schoonmaakmiddelen. Deze zijn het minst agressief en het minst schadelijk voor het milieu en onze handen. Het gebruik van schuurmiddelen op basis van zand wordt afgeraden. Door het veelvuldig schuren met deze middelen wordt de bovenste laag van het glazuur afgeschuurd, waardoor vuil in de toplaag gaat zitten. De polijstmiddelen op basis van krijt kunnen wel normaal op keramiek gebruikt worden omdat dit zacht is en dat het een polijstende in plaats van een schurende werking heeft.

Reiniging en onderhoud

Voor dagelijkse reiniging adviseren we de conventionele schoonmaakmiddelen of schoonmaakmiddelen op basis van azijn. Voor een zachte maar grondige reiniging adviseren wij Cramer Email Keramiek. Metalen schaafplekken, vaak grijze lijnen kunnen makkelijk worden verwijderd met de Cramer Bath-Rubber.

Behandeling van krassen

Keramiek is bij normaal gebruik dus heel kraswerend. Maar echte diepe krassen in het oppervlak (meestal het gevolg van een grove botsing met een zwaar of scherp voorwerp) zijn met de gebruikelijke schoonmaakmiddelen niet te verwijderen. Kleine beschadigingen daarentegen kunnen worden hersteld met de Cramer Touch-up Stick en het Cramer Reparatieset kan worden toegepast bij iets grotere beschadigingen en bijvoorbeeld bij impactschade op de randen van de wasbak.

/ The surface of all ceramic / porcelain washbasins consists of a glazed, thin, glass-like layer. Porcelain are characterized by user-friendliness and the smooth surface. That does not mean it is insensitive to damage. Hard falling objects can damage the enamel, which can lead to irreparable cracks and surface damage.

Removing stains

For daily cleaning you can use normal cleaning agents such as all-purpose cleaners for sanitary facilities. Any limescale residues can be removed with, for example, the commercially available limescale removers or the regular vinegar-based cleaning products. These are the least aggressive and the least harmful to the environment and our hands. The use of sand-based abrasives is not recommended. By frequently sanding with these abrasives the top layer of the glaze will be scoured off, leaving dirt in the top layer. The chalk-based polishes are better to use on porcelain because they are soft and have a polishing effect instead of an abrasive effect.

Cleaning and maintenance

For daily cleaning, we recommend conventional cleaning agents or vinegar-based cleaning agents. For a gentle but thorough cleaning, we recommend Cramer Email Keramiek. Metal scrapes, often gray lines, can be easily removed with the Cramer Bath-Rubber.

Treatment for scratches

Porcelain are very scratch-resistant in regular use. However, really deep scratches in the surface (usually the result of a rough impact with a heavy or sharp object) cannot be removed with the usual cleaning products. Minor damage, on the other hand, can be repaired with the Cramer Touch-up Stick. The Cramer Repair Set can be used for slightly larger damage and, for example, impact damage on the edges of the sink.

POLYSTONE / POLYSTONE

Polystone wastafels hebben een basis van minerale vulstoffen en een polyester/epoxy bindmiddel en zijn voorzien van een harde kunststof toplaag (gelcoat). Ze zijn gemakkelijk schoon te maken en schoon te houden met water en de gebruikelijke in de supermarkt verkrijgbare huishoudelijke reinigingsmiddelen.

Verwijderen van vlekken

Vlekken zijn door het gladde oppervlak eenvoudig te verwijderen met een vochtige doek of gewoon met water en een vloeibaar afwas- of reinigingsmiddel. Gebruik geen chemische middelen zoals bijvoorbeeld bleekwater, haarverf of nagellakverwijderaar/acetone. Deze middelen kunnen de wastafel onherstelbaar beschadigen en/of verkleuren.

Opmerking: puntige vallende voorwerpen kunnen het oppervlak beschadigen. Mineraal gegoten composieten zijn gevoeliger voor krassen dan keramiek/porselein en zijn niet bestand tegen temperaturen die continu hoger zijn dan 65 graden Celsius.

Moelijk te verwijderen vlekken en lichte, oppervlakkige krassen kunnen ook verwijderd worden met behulp van de Cramer Acryl-Mineral. De Cramer Touch-up Stick en de Cramer Reparatieset kunnen worden toegepast bij kleine beschadigingen.

Reiniging en onderhoud

Mineraal gegoten composieten mogen alleen worden gereinigd met een zachte spons/doek en een zandvrije vloeibare reiniger of het speciale poetsmiddel: Cramer Acryl-Mineral en reinigingsmiddel: Cramer Mineral-Cast-Cleaner.

/ Polystone washbasins have a base of mineral fillers and a polyester / epoxy binder and are provided with a hard plastic top layer (gelcoat). They are easily cleaned and kept clean with water and common household cleaners available in the supermarket.

Removing stains

Due to the smooth surface, stains can easily be removed with a damp cloth or simply with water and a liquid dishwashing or cleaning agent. Do not use chemicals such as bleach, hair dye or nail polish remover / acetone. These agents can irreparably damage and / or discolour the washbasin.

Note: Pointed falling objects can damage the surface. Mineral cast composites are more susceptible to scratches than ceramic / porcelain and cannot withstand temperatures that are continuously higher than 65 degrees Celsius.

Difficult to remove stains and light superficial scratches can be removed with the help of the Cramer Acryl-Mineral. The Cramer Touch-up Stick and the Cramer Repair Set can be used for minor damage.

Cleaning and maintenance

Mineral cast composites should only be cleaned with a soft sponge / cloth and a sand-free liquid cleaner or the special polish: Cramer Acryl-Mineral and cleaning agent: Cramer Mineral-Cast-Cleaner.

HARDSTEEN / BLUE STONE

Hardsteen is een natuurproduct en kan dus qua kleur en structuur afwijken van wat u in de winkel hebt gezien. Hardsteen is ook niet ongevoelig voor krassen.

Verwijderen van vlekken

Hardsteen is poreus materiaal waardoor er altijd vlekken kunnen ontstaan. Reinig daarom onmiddellijk na het morsen en houd het oppervlak stofvrij. Laat de vervuiling zich niet ophopen (make-up, water, etc.) en spoel de wastafel na gebruik grondig met water en wrijf droog met een zachte doek.

Bij montage van de hardstenen wastafel mag er alleen zuurvrije kit gebruikt worden. Het zou kunnen dat er in andere kitsoorten olie zit en die trekt onmiddellijk in de steen en geeft dan vlekken die niet meer te verwijderen zijn. Zuren en alkalische stoffen zijn erg slecht voor de glanzende toplaag. Wij adviseren deze materialen niet te gebruiken: zuurhoudende toilet- en tegelreinigers, ammoniak, schurende (vloeibare) reinigingsmiddelen, citroen(zuur), azijn, alcohol, ruitenreinigers, schuursponsjes, staalwol.

Behandeling van krassen

Hardsteen is niet bestand tegen alle soorten vlekken en krassen. Een waterafstotende sealer/impregneermiddel gaat het binnendringen van vloeistoffen tegen. Dit betekent niet dat het blad hierdoor volledig beschermd wordt. Het is raadzaam om minstens één keer per jaar het steenoppervlak te beschermen met een sealer/impregneermiddel.

Reiniging en onderhoud

Voor de dagelijkse reiniging en onderhoud van de wastafels en waskommen met de Lithofin Natuursteen Care-Kit wordt het hardsteen gereinigd, geïmpregneerd en is direct klaar voor dagelijks onderhoud. Natuursteen Care-Kit is dé onderhoudsset om uw natuursteen te beschermen en te onderhouden.

/ Blue stone is a natural product and can therefore differ in color and structure from what you have seen in the store. Blue stone is also not insensitive to scratches.

Removal of stains

Blue stone is a porous material, which could always cause stains. Therefore, clean immediately after spillage and keep the surface free of dust. Don't let the pollution build up (make-up, water, etc.), after use rinse the washbasin thoroughly with water and wipe it dry with a soft cloth.

Only acid-free sealant may be used when mounting the blue stone washbasin. It could be that there is oil in other types of sealant, the blue stone immediately absorbs this therefore the stains cannot be removed. Acids and alkalis are very bad for the glossy top coat. We recommend not to use these materials: acidic toilet and tile cleaners, ammonia, abrasive (liquid) cleaning agents, lemon (acid), vinegar, alcohol, window cleaners, scouring pads, steel wool.

Treatment of scratches

Blue stone is not resistant to all types of stains and scratches. A water-repellent sealer / impregnation agent prevents the penetration of liquids. This does not mean that the washbasin is completely protected by this. It is advisable to protect the stone surface with a sealer / impregnation agent at least once a year.

Cleaning and maintenance

For the daily cleaning and maintenance of the washbasins and countertops with the Lithofin Natural Stone Care-Kit, the blue stone is cleaned, impregnated and is immediately ready for use. daily maintenance. Natural stone Care-Kit is the maintenance kit to protect and maintain your natural stone.

Vraag uw sanitair specialist voor meer info over genoemde onderhoudsartikelen of kijk op onze website www.sanibell.nl/shop

/ Ask your sanitary specialist for more information about the mentioned maintenance items or visit our website www.sanibell.nl/shop

KLEURUITVOERINGEN / COLOUR VERSIONS

PORSELEIN / PORCELAIN



POLYSTONE / POLYSTONE



HARDSTEEN / BLUE STONE



LAK GEFREESD & ONGEFREESD / LACQUER MILLED & UNMILLED



HOUTDECOR / DECOR

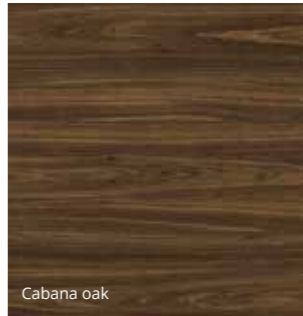
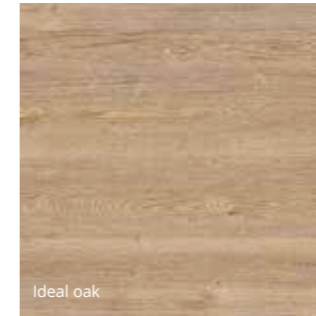
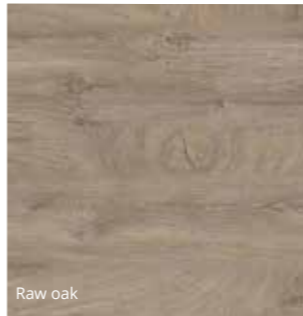

HOUTDECOR GEFREESD / WOOD DECOR MILLED

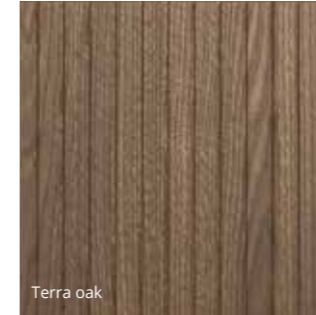
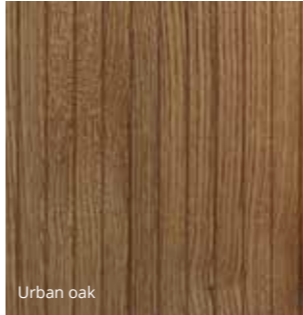

De in deze brochure afgebeelde kleuren geven een indicatie van de werkelijkheid. Hardsteen is een natuurproduct en kan dus qua kleur en structuur afwijken van wat u in de winkel hebt gezien. Kleurstalen kunt u bekijken bij de Proline dealers of bestellen via de website www.sanibell.nl/shop

/ The colours shown in this brochure give an indication of reality. Blue stone is a natural product and can therefore differ in colour and structure from what you have seen in the store. Colour samples can be viewed at the Proline dealers or ordered on the website www.sanibell.nl/shop

PROLINE

badkamermeubelen / *bathroom furniture*

Sanibell Nederland

Ferrarilaan 8
3261 NC Oud-Beijerland
The Netherlands
www.sanibell.nl
info@sanibell.nl

Sanibell Belgium

Sluis 2A unit 2
9810 Eke
Belgium
www.sanibell.be
info@sanibell.be

International:

www.sanibell.nl
export@sanibell.nl

www.prolinebadkamermeubelen.nl

